RouteFinder[™]

**Model RF802EW
Wireless Router/Access Point**

User Guide

User Guide

Wireless Router/Access Point
Model RF802EW
P/N S0000178 Revision B

Copyright

This publication may not be reproduced, in whole or in part, without prior expressed written permission from Multi-Tech Systems, Inc. All rights reserved.

Copyright © 2001 by Multi Tech Systems, Inc.

Multi-Tech Systems, Inc. makes no representations or warranties with respect to the content hereof and specifically disclaims any implied warranties of merchantability or fitness for any particular purpose. Furthermore, Multi-Tech Systems, Inc. reserves the right to revise this publication and to make changes from time to time in the content hereof without obligation of Multi-Tech Systems, Inc. to notify any person or organization of such revisions or changes.

Record of Revisions

<u>Revision</u>	<u>Date</u>	<u>Description</u>
A	06/06/01	Manual released.
	10/04/01	Recreated PDF.
B	10/22/01	Added Web browser configuration and management chapter, Wireless Setting section to the Telnet chapter, Add MAC Access Control section to the RouteFinder Manager chapter.

Patents

This device is covered by one or more of the following patents: 6,219,708; 6,031,867; 6,012,113; 6,009,082; 5,905,794; 5,864,560; 5,815,567; 5,815,503; 5,812,534; 5,809,068; 5,790,532; 5,764,628; 5,764,627; 5,754,589; D394,250; 5,724,356; 5,673,268; 5,673,257; 5,644,594; 5,628,030; 5,619,508; 5,617,423; 5,600,649; 5,592,586; 5,577,041; 5,574,725; D374,222; 5,559,793; 5,546,448; 5,546,395; 5,535,204; 5,500,859; 5,471,470; 5,463,616; 5,453,986; 5,452,289; 5,450,425; D361,764; D355,658; D355,653; D353,598; D353,144; 5,355,365; 5,309,562; 5,301,274. Other Patents Pending

Trademarks

Trademark of Multi-Tech Systems, is the Multi-Tech logo. Windows, Windows 95, 98, NT and 2000 are trademarks of Microsoft. All other trademarks are owned by their respective companies.

World Headquarters

Multi-Tech Systems, Inc.
2205 Wooddale Drive
Mounds View, Minnesota 55112 U.S.A.
(763) 785-3500 or (800) 328-9717
U. S. FAX (763) 785-9874
Technical Support (800) 972-2439
Internet Address: <http://www.multitech.com>

Contents

Chapter 1 - Introduction	6
Description of the RF802EW RouteFinder	6
Front Panel	7
Back Panel	7
Typical Applications	8
Connecting a Remote Site via Cable Modem	8
Connecting a Local Site to the Internet	8
Specifications	9
Chapter 2 - Hardware Installation	11
Safety	11
Unpacking the RF802EW	11
Cabling	12
Chapter 3 - Software Installation and Configuration	14
Software Installation	14
Using RouteFinder Setup Wizard	15
Remote Access	19
Testing Your Connection	23
Chapter 4 - Web Browser Management and Configuration	25
Using a Web Browser to Configure Your RouteFinder	25
Setup Wizard	26
Setup Wizard Screen	27
Setup Wizard - Time Settings	28
Setup Wizard - ADSL/Cable ISP Settings	29
Setup Wizard - ISP Additional Settings (PPPoE Settings)	30
Setup Wizard - Wireless Settings	31
Setup Wizard - Modem Settings	32
Setup Wizard - Save and Restart	32
Device Information	33
Device Status	34
Advanced Settings	35
Advanced Settings - DHCP Server Settings	35
Advanced Settings - Virtual Server Settings	36
Advanced Settings - Static Routing	37
Advanced Settings - Dynamic Routing	38
Advanced Settings - Modem String Settings	39
Advanced Settings - Administrative Settings	40
System Tools	41
System Tools - Intruder Detection Log	41
System Tools - Display Routing Table	42
System Tools - System Diagnosis	43
System Tools - Load Default Settings	44
System Tools - Upgrade Firmware	45
System Tools - Reset Device	46

Chapter 5 - Using Telnet to Configure Your RouteFinder	48
Starting a Telnet Session	48
Server Menu Options.....	49
Chapter 6 - RouteFinder Manager	55
Accessing the RouteFinder Manager Software	55
Description of the RouteFinder Manager Main Screen	56
General Settings Option on the Manager Main Screen	60
General Settings Options	61
Remote Access Settings	66
Enable IP Mapping - Virtual Server.....	67
Port Settings Option from the Manager Main Screen	69
LAN DHCP Server Option from the Manager Main Screen	74
Routing Settings Option from the Manager Main Screen	76
Filter Settings Option from the Manager Main Screen	78
Wireless Settings Option from the Manager Main Screen	82
MAC Access Control Option from the Manager Main Screen	83
Chapter 7 - RouteFinder Monitor	85
Accessing the RouteFinder Monitor	85
Screen Options	85
Chapter 8 - LAN Client Settings	94
Introduction	94
Setting Up Remote Access Clients	94
Accessing a Windows NT Server	94
Accessing a Novell Server	104
Accessing a Windows NT Server and a Novell NetWare Server	107
Accessing a Unix Server	112
Make New Connection (Windows 2000 only).....	114
Chapter 9 - LAN-to-LAN Settings	117
Chapter 10 - Troubleshooting	120
Chapter 11- Service, Warranty, and Technical Support	124
Software User License Agreement	126
Technical Support.....	128
Appendix A - Regulatory Compliance Information	131
Appendix B - Tools for your RF802EW	132
Appendix C - Cabling Diagrams.....	134
Index	140

RouteFinder[™]

Chapter 1
Introduction

Chapter 1 - Introduction

Description of the RF802EW RouteFinder

Congratulations on the purchase of the Multi-Tech System's RouteFinder model RF802EW, one of the finest broadband routers available today.

The RouteFinder RF802EW provides wireless users with seamless access to their existing wired LAN, enabling them to share broadband access to the Internet as well as other resources. Using the IEEE 802.11b wireless standard, the RouteFinder provides increased speed--up to 11 Mbps--and mobility between the desktop, conference room, or campus. It supports a DSL or cable modem connection to the Internet to provide shared Internet access for up to 253 users. The RF802EW includes one asynchronous port for backup Internet access or dial-in remote access.

Wireless Networking. The RouteFinder's integrated IEEE 802.11b-compliant access point provides mobility, enabling access to shared resources without requiring a physical connection. The RouteFinder also communicates with other access points on the network to provide roaming from one cell to another.

Connects up to 253 internal IP addresses to the Internet with broadband speed. The RouteFinder can be configured as a DHCP server to handle requests for Internet services and route to and from the ISP. Up to 253 internal IP addresses are connected to the Internet with only one IP account. The WAN Ethernet port has a bandwidth of 10 Mbps which is 179 times faster than a 56k modem and can support DSL or cable speeds of up to 5 Mbps.

Network Security. The RouteFinder uses 64-bit WEP encryption for wireless LAN security. WEP prevents intruder access to the network and prevents the capture of wireless LAN traffic by eavesdropping. The RouteFinder uses the NAT protocol to provide security from hackers attempting to access the office LAN without the extra cost of a firewall. It implements firewall and gateway security for LAN-based resources. Additionally, the RouteFinder supports Internet access restriction by IP address, client protocols or a list of forbidden sites.

Dial Backup or Dial-in RAS Port. The RouteFinder also provides an additional asynchronous port that, when connected to a dial-up modem or ISDN terminal adapter, serves as a backup resource for Internet access if your cable or DSL service goes down. It can also serve as dial-in remote access for your telecommuters or mobile users.

Virtual Server Support. In addition to providing shared Internet access, the RouteFinder can support Web, FTP or other Internet servers. Once configured, the RouteFinder accepts only unsolicited IP packets addressed to the Web or FTP server.

LAN Segmentation. For added LAN security, the RouteFinder can be used to segment the LAN by connecting the corporate servers to one RouteFinder Ethernet port and the Internet Servers to the other Ethernet port. This configuration puts the corporate servers behind a firewall and the Internet servers outside the firewall. To continue to provide Internet access, connect a modem, or ISDN terminal adapter to the RouteFinder's asynchronous port.



The RouteFinder RF802EW

Front Panel

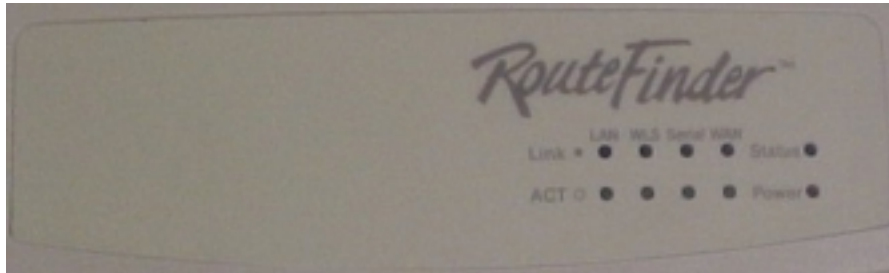

RF802EW Front Panel

Front Panel Description

Link	Lights when the LAN client is correctly connected to the 10/100 LAN.
ACT	Blinks when transmitting or receiving packets.
LAN	Lights when a successful connection to the 10/100 LAN is established.
WLS	Lights when a wireless connection is established.
Serial	Lights when the Serial async port is properly connected to a remote site.
WAN	Lights when a successful connection to the 10Base-T WAN is established.
Status	Blinks when updating flash ROM or rebooting.
Power	Lights when power is being supplied to the router.

Back Panel



RF802EW Back Panel

Back Panel Description

Power 5V DC	The 5V DC power socket is used to connect the device to the AC power adapter.
10 BT WAN	The WAN port is used to connect the router to a DSL or Cable modem.
Serial	The Serial async port connects the router to a standard modem (optional).
10/100M	Connects the Router to a 10/100 Base-T Ethernet LAN.
Reset	Press and hold for three seconds to reset the router to factory defaults.
Uplink/Normal	Slide the switch to the Uplink position to use the LAN port to expand your network by connecting a network cable to another router, switch, or hub. To connect the port to a LAN client workstation, slide the switch to the Normal position.

Typical Applications

The following examples provide information about typical applications using the RF802EW. They describe using the RF802EW to connect a remote site via a cable modem, using the RF802EW to segment a local area network, and using the RF802EW to connect a LAN to the Internet using one shared IP address.

Connecting a Remote Site via Cable Modem

In the following example the RF802EW is used to connect a LAN to the Internet via DSL or a cable modem.

Kernal: **NAT** (outgoing TCP/IP connection sharing a single Internet IP address or using multiple IP mapping)

- Virtual Server (allowing incoming specific TCP/IP service request redirect to an internal server)
- Static Routing (Routing table setting to Internal Local Gateways)
- Firewall

External: Fixed External Port IP or DHCP client (Dynamic IP assigned)

Internal: Device Fixed IP
DHCP Server

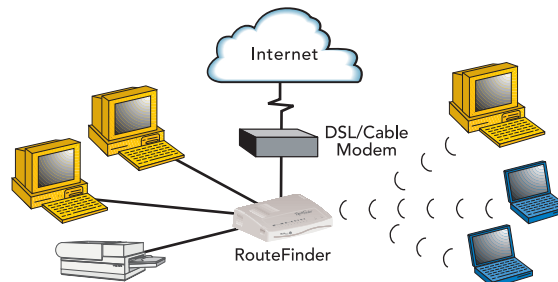

Connect Remote Site via Cable Modem

Connecting a Local Site to the Internet

In this application, the RF802EW is used to connect up to 253 Internal IP addresses to the Internet using a single shared external IP address.

Kernal: **NAT** (outgoing TCP/IP connection sharing single External Port IP or using multiple IP Mapping)

- Virtual Server (allow incoming specific TCP/IP service request redirect to internal server)
- Firewall

External: Fixed External Port IP and mask DNS IP, Gateway IP or DHCP client (Dynamic IP for the device, DNS and Gateway assigned.)

Internal: Device Fixed IP
DHCP Server

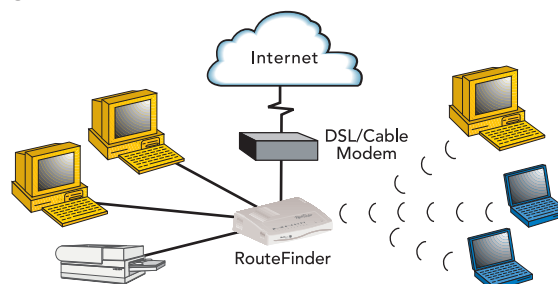

Connect Local Site (1 External IP address = 253 Internal IP addresses)

Specifications

Hardware	ARM RISC CPU 32 bit, 40MHZ 4MB DRAM and 512k Flash ROM UART Serial port controller
LAN Port	Interface: 1 10Base-T/100BaseTX RJ-45 Connection Standard: 802.3
WAN Ports	1 x 10Base-T 1 x RS232 (V.24) DTE Speed: Up to 230K asynchronous
Wireless Access Point	IEEE 802.11b for wireless LAN Data Rates: 11, 5.5, 2, 1 Mbps data rate per channel RF Frequency: 2.4-.24835 Ghz Emission Type: Direct Sequence Spread Spectrum Operating Range: Up to 100 meters indoors and 300 meters outdoors Antenna: Dual Dipole with Diversity Antenna Gain: 2 dB MAX
Protocols	Security: PAP/CHAP, NAT Firewall, RADIUS, Callback, WEP Network: TCP/IP, IPX, DHCP, PPP, PPPoE Routing: Static, RIP 1, VPN, IPsec & PPTP Pass-Through Filtering: Protocol, port number, and IP address
Power Output	5V DC, 2000mA
Dimensions	7.1" x 4.9" h x 1.4" d (18.1 cm x 12.5 cm x 2.5 cm)
Weight	380g 13 oz.
Memory	RAM: 4MB Flash ROM: 512k
Operating Environment	Temperature Range: 32-120 degrees F (0-50 degrees C) Humidity: 25-85% non-condensing
Approvals	FCC Part 15 Class B & ETS 300 328
Warranty	2-year warranty

RouteFinder[™]

Chapter 2 Hardware Installation

Chapter 2 - Hardware Installation

Safety

1. Never install telephone wiring during a lightning storm.
2. Never install telephone jacks in a wet location unless the jack is specifically designed for wet locations.
3. This product is to be used with UL and cUL listed computers.
4. Never touch uninsulated telephone wires or terminals unless the telephone line has been disconnected at the network interface.
5. Avoid using a telephone during an electrical storm. There may be a remote risk of electrical shock from lightening.
7. Do not use the telephone to report a gas leak in the vicinity of the leak.
8. To reduce the risk of fire, use only No. 26 AWG or larger telecommunications line Cord.

Unpacking the RF802EW

The RF802EW shipping box contains the following items:

- System CD
- Tucows CD
- Power Supply
- The RouteFinder RF802EW
- The RF802EW RouteFinder Quick Start Guide

If any of the items is missing or damaged, please contact Multi-Tech Systems.

Cabling

Cabling your RouteFinder requires making the appropriate connections to PCs, Cable, or DSL modem, analog modem or ISDN TA (optional), AC power and the router. Because this device also acts as a DHCP server, after your device is properly cabled, you will need to follow the configuration instructions provided in the Software Installation and Configuration chapter.

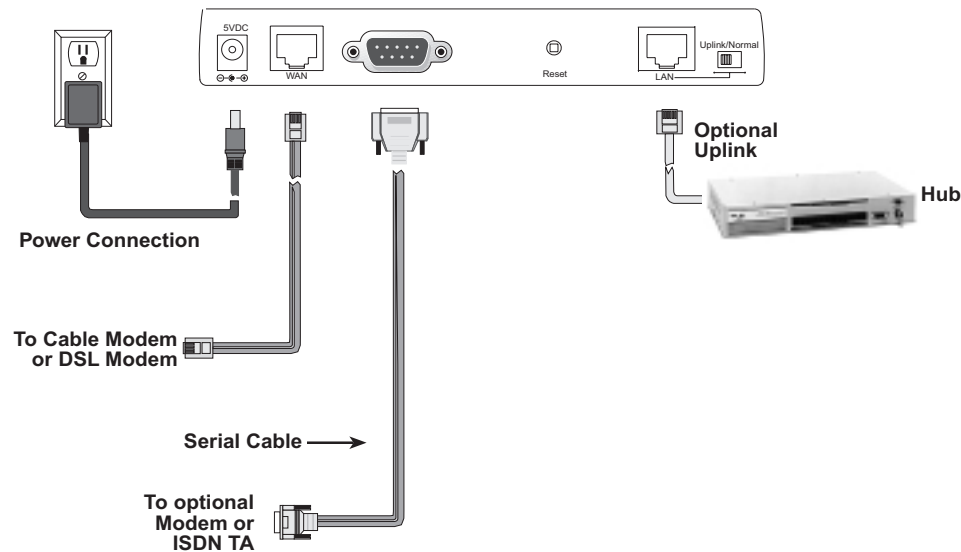

Cabling the RouteFinder RF802EW

1. Before beginning, turn the power off on all network devices (PCs, Cable, DSL modems, analog modems, ISDN TAs and the router).
2. Connect the Ethernet port of each PC or network device to the LAN port.
3. If you are using an analog modem, connect it to the Serial Async port.
4. If you are using the Uplink option to connect to another network segment, slide the **Uplink/Normal** switch into the **Uplink** position. Connect the LAN cable to LAN port #1. Plug the other end of the LAN cable into another hub, router, or switch.

Note: If you are not using the Uplink feature, place the switch in the **Normal** position.

5. Connect a network cable from the cable or DSL modem to the 10 BT WAN port.
6. Connect the provided power supply cable to the 5V DC power port on the back of the router. Plug the power supply into an AC power outlet as shown above.
7. Power on your DSL or Cable modem.
8. If you are using an analog modem or ISDN TA, power on the device.
9. You are ready to configure software for your RouteFinder and network PCs.

RouteFinder[™]

Chapter 3
Software Installation
and Configuration

Chapter 3 - Software Installation and Configuration

Before beginning the installation process, ensure that your system meets all hardware and software requirements:

- Intel 486 or higher processor.
- 10/100 Base-T cable to connect the RF802EW to the network.
- One DSL or Cable Modem.
- A networked computer with Windows 95/98/2000, Windows NT 3.5 or higher and TCP/IP protocol installed (or, a non-Windows system with TCP/IP properly installed to enable Telnet configuration).
- Any PPP supported communication application for Dial-In operation.
- TCP/IP installed and configured on each workstation accessing the Internet.

Software Installation

The software installation process involves installing the RouteFinder Utilities, including RouteFinder Setup Wizard, RouteFinder Manager and RouteFinder Monitor. A description of each component follows:

RouteFinder Setup Wizard

The RouteFinder Setup Wizard provides a step-by-step process to assist you in entering all the basic settings needed to configure your RF802EW for general use. All settings that are entered in the Setup Wizard can be found in their respective menus in the RouteFinder Manager.

RouteFinder Manager

RouteFinder Manager is the main program used to configure all settings for your RF802EW. Complete information about options within the RouteFinder Manager can be found in the RouteFinder Manager chapter in this User Guide.

RouteFinder Monitor

RouteFinder Monitor is a multi-purpose utility designed to let you know the status of your RF802EW connection. The monitor offers the ability to point and click on an event to access troubleshooting procedures. Refer to the RouteFinder Monitor chapter in this User Guide for more information.

Using RouteFinder Setup Wizard

Note: Before beginning this procedure, ensure that your RF802EW is properly connected to the network and that the power is turned on.

After installing the software, you may return to the RouteFinder Setup Wizard at any time, by clicking **Start | Programs | RouteFinder Manager | RouteFinder Wizard**.

Before running the Setup Wizard, it is strongly recommended that you exit all Windows programs.

1. Insert the RF802EW System CD into your computer's CD-ROM drive. The RF802EW System CD window appears.

Note: If Autorun is disabled on your computer, use Windows Explorer to view the contents of the CD. **Double-click** the CD icon to display the RF802EW System CD main window.

2. Click **Install Software**.
3. Follow the on-screen instructions to install the software.
4. When the software installation completes, the **Setup Wizard** dialog box displays. Click **OK**.



5. The **Setup Wizard: Device List** dialog box displays. The Setup Wizard automatically checks your network for available network devices and displays them.

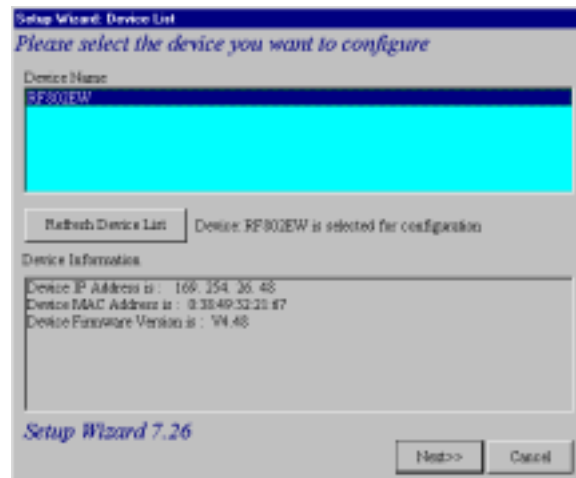

Select the device you wish to configure from the **Device Name** list.

Record the values presented in the **Device Information** panel for later reference.

Device IP Address _____

Device MAC Address _____

Device Firmware Version _____

Click **Next**.

Note: If a message appears indicating the device is not found, or you do not see the device you are attempting to configure listed, click **Refresh Device List**.

6. The **Setup Wizard: Device IP Address** dialog box displays.

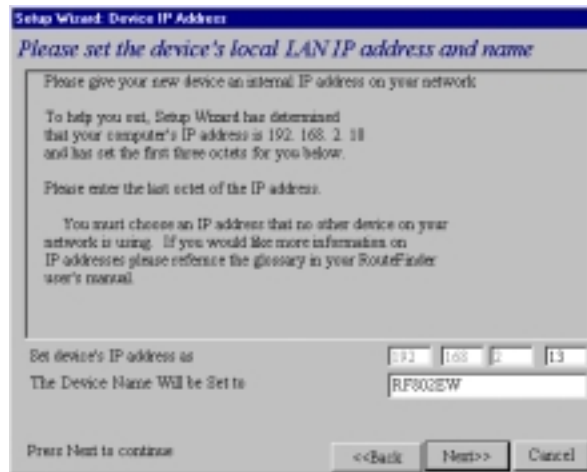

- **Enter** your local internal network's IP address for this device.

The Setup Wizard will automatically detect the first three octets of your local IP address. You must enter the last octet only.

- If you wish, you can change the network name of your RouteFinder. If your ISP requires your device to have a name, you may use the name entered here.
- Click **Next** to continue. The device will search the network to ensure that the IP address is valid. This may take several seconds.

Note: If your ISP provided you with an IP address, do not enter that address. Enter the IP address for this device on your local network. Refer to the Glossary for additional information on IP addressing.

7. The **Wireless Function** dialog box displays.

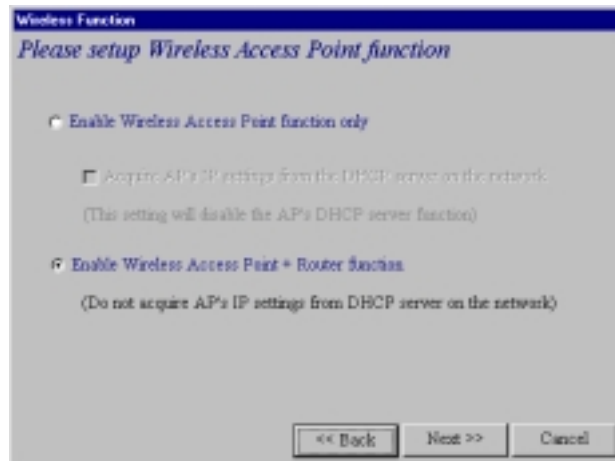

Select the function for the wireless port function by selecting **Enable Wireless**

Access Point function only, or Enable Wireless Access Point + Router function. If you are using NAT Enabled, you may also select **Enable PPPoE**.

- Select **Enable Wireless Access Point function only** to set AP's IP manually or acquire an IP address from a DHCP server.
- Select **IP Routing (NAT Disabled)** to allow the RF802EW to function as a router between the IP segment of the server and another IP segment. This option is ideal for organizations needing to segment workgroups.
- Select **Enable PPPoE** to use the RF802EW with a time-base, rather than fixed-cost DSL modem connection. Enter the User Name and Password provided by your ISP. This option is most often used when connecting via DSL to the Internet.

Note: Enable PPPoE is valid only when IP Routing (NAT Enabled) is selected.

Click **Next** accessing the Internet. This option is most often used when the RF802EW is connected to a DSL or cable modem, or when the IP segment of the server needs firewall protection.

8. The **Wireless Settings** dialog box displays.

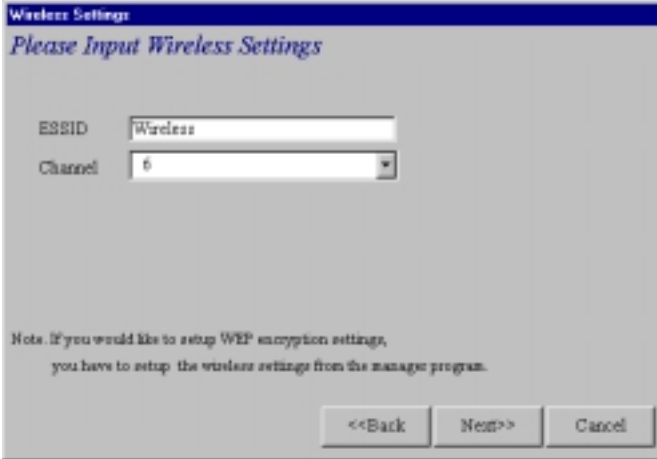

The image shows a dialog box titled "Wireless Settings" with the subtitle "Please Input Wireless Settings". It contains two input fields: "ESSID" with the text "Wireless" and "Channel" with the value "6". Below the fields is a note: "Note: If you would like to setup WEP encryption settings, you have to setup the wireless settings from the manage program." At the bottom are three buttons: "<<Back", "Next>>", and "Cancel".

In the **ESSID** box, enter the wireless ID. **Wireless** is the default ID. From the Channel list, select a channel. **6** is the default channel. All workstations must have the same ESSID. Make sure that the channel is correct for your network.

Click **Next**.

9. The **Select Function** dialog box displays.



The image shows a dialog box titled "Select Function" with the subtitle "Please select the function of WAN Ethernet". It has three radio button options:

- IP Routing (NAT Enabled): Local users can share an external IP address to the Internet. (Most often used when the device is connecting to an ADSL / Cable Modem) Or when the IP segment of the server needs to be firewall protected.
- IP Routing (NAT Disabled): Function as a router between the IP segment of the server and the other IP segment.
- Enable PPPoE: Includes fields for "User Name" and "Password".

 At the bottom are three buttons: "<<Back", "Next>>", and "Cancel".

Select **IP Routing (NAT Disabled)** to allow the RF802EW to function as a router between IP segments. This option is ideal for organizations needing to segment workgroups.

Select **Enable PPPoE** to use the RF802EW with a time-base, rather than fixed-cost DSL modem connection. Enter the User Name and Password provided by your ISP. This option is most often used when connecting via DSL to the Internet.

Note: Enable PPPoE is valid only when IP Routing (NAT Enabled) is selected.

Click **Next**.

10. The **External IP Assignment** dialog box displays.

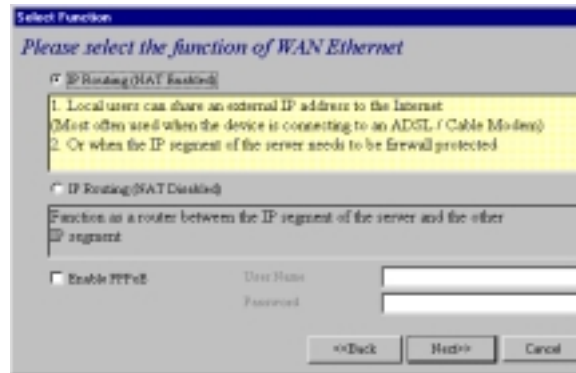

Enter the WAN Ethernet IP address information provided by your ISP or other external network administrator.

- In the **External IP Address** box, enter the WAN Ethernet IP Address.
- In the **External IP Netmask** box, enter the Netmask of the WAN Ethernet IP Segment. For Class C networks, the Netmask is generally set to 255.255.255.0).
- In the **External Gateway IP Address** box, enter the IP address of the Gateway to the destination network.

Note: If your ISP uses dynamic IP addressing (DHCP), leave the External IP address and the External Gateway IP address at the default values of 0.0.0.0. Set the External IP Netmask to the default value of 255.255.255.0.

Click **Next**.

11. The **Asynchronous port function** dialog box displays. Select **1) Remote Access**, **2) IP Routing (NAT Enabled)** or **3) IP Routing (NAT Disabled)**.

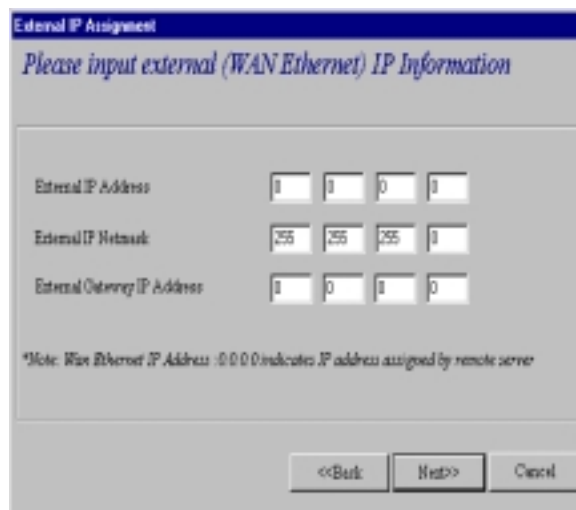

- Select **Remote Access** to allow remote users to dial-in to the network to access resources as if the remote user is connected to the network locally. See the Remote Access instructions for more information.

- Select **IP Routing (NAT Enabled)** to allow all users in the two IP segments (LAN and WAN Ethernet) to share one IP address to the Internet. You may also select this option to use the serial async port for dial backup in the event the DSL or cable modem becomes unavailable.
- Select **IP Routing (NAT Disabled)** to connect other IP segments through the serial async port. See the IP Routing instructions continue on page 26.

Note: The IP Routing (NAT Enabled) feature of the serial async port is valid only if the WAN port is configured as NAT Disabled.

Click **Next**.

Remote Access

You must define the location of your remote user account database by selecting **Use Local Client List** or **Use RADIUS Server**.

Note: The Local Client List allows you to add a maximum of 64 users.

Use Local Client List

Use Local Client List allows you to create an authentication database consisting of user names, passwords and dial-in options for each remote user. You must provide the following information for each client:



User Name

Enter the User Name to authenticate the remote dial-in user.

Password

Enter the Password to authenticate the remote dial-in user. Passwords are limited to 16 characters.

Password Verification

Re-enter the remote dial-in user's password.

Callback Type

Select one of the following three callback options for each remote client:

- **No Callback:** Select this option to allow the remote user to immediately connect to the network after being authenticated. This is the default setting.
- **Fixed Callback:** This option allows you to specify a fixed callback telephone number for the user. After the PPP negotiation, the device will disconnect, then callback the telephone number you entered. This option is best used for clients requiring callback security while dialing-in from the same location each time.

- **Variable Callback:** Select **Variable Callback** for remote users that travel or dial-in from various locations and need callback security. This option allows clients to specify the callback telephone number each time they connect to the network.

Click **Add** after entering information for each Local Client.

Click **Next** and continue with Step 10 when all users have been added to the database.

Use RADIUS Server

Select this option if you would like your remote clients to be authenticated on a RADIUS server. You must enter the following RADIUS Server Settings:

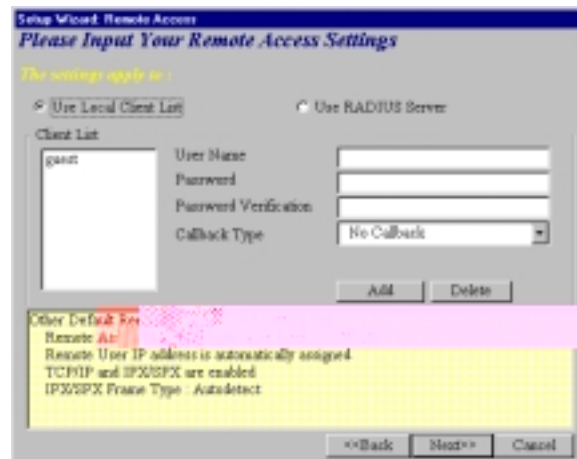

RADIUS Access Server IP Address

Enter the IP address of the RADIUS Access Server.

RADIUS Accounting Server IP Address

Enter the IP address of the RADIUS Accounting Server.

Secret

Enter your Shared Secret.

Secret Verification

To confirm your Shared Secret, re-enter your Shared Secret.

Note: In most cases, the RADIUS Access Server and the RADIUS Accounting Server are the same server, so the IP addresses will also be the same.

Click **Next**.

IP Routing (NAT Enabled) and IP Routing (NAT Disabled)

Select from the Asynchronous Port Function Screen

If you select **IP Routing** for the asynchronous port, the **Setup Wizard: IP Routing** dialog box displays.

Enter the information required to dial-up and login to your ISP's remote server:

Telephone Number

Enter the phone number used to dial your remote server (ISP).

Note: If you must dial a number to get an outside line (for example, "9", or "0"), enter the required number plus a "w" (wait) or a comma in the **Telephone** box (for example, 9w555-2323 or 9,,5552323). Each comma provides a 3-4 second delay.

User Name

Enter the User Name for your remote server or ISP account.

Password

Enter the Password for your remote server or ISP account.

Password Verification

Re-enter the password for your remote account.

Click **Next**.

12. The **Setup Wizard: DNS IP Address** dialog box displays.

Enter your ISP's DNS Server IP address. If you are not sure of the IP address, contact your ISP. Refer to the Glossary in the User Guide for more information about the DNS Server.

Click **Next**.

13. The **Setup Wizard: Modem Settings** dialog box displays.



Use this dialog box to define your modem Manufacturer, Model and the DTE baudrate (speed) of communication between the RF802EW's serial async port and your modem or ISDN TA.

Note: If you do not have a device attached to the serial async port, use the default modem values, and click **Next**.

14. To select your **modem**, in the **Asynchronous port settings** box, click . The system loads modem information.

15. The **Modem Initial Command** dialog box displays.

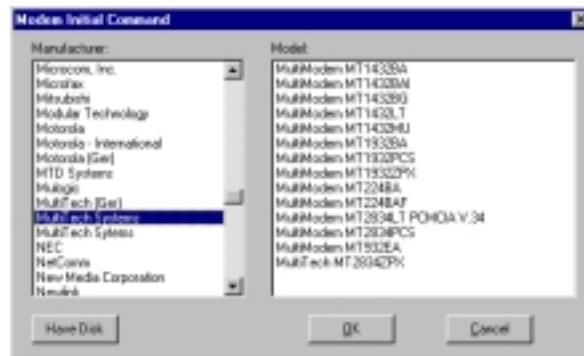

Select your modem manufacturer, then select the model from the list provided. Click **OK**. If your modem is not listed and you have a driver disk, click **Have Disk...** to install your modem.

Note: This setting configures the initial string of the RF802EW asynchronous port so that it will know how to communicate with your modem. If using an analog modem and this modem is not included in the selection list, in most cases, Standard Modem will work. If you are using an ISDN TA, refer to the ISDN TA's User Guide for information on the initialization and hang up strings. Use RouteFinder Manager to enter modem strings.

16. The **Setup Wizard: Modem Setting** dialog box re-displays. Use the **Asynchronous port settings** list to select the baudrate. Select the DTE speed (the speed of communication between the asynchronous port of the RF802EW and the modem). For DCE speed compression modems, this value can normally be set to about 4 times the speed of your modem. Keep in mind that if you set the baudrate too high, the dial-up connection may fail.

Note: You may need to set a lower baudrate since the theoretical maximum connection speed may not be attainable due to variations in quality of phone line and ISP connections.

Click **Next** to complete the basic configuration.

17. The **Check List** dialog box displays summarizing your configuration selections. Ensure that all values have been correctly entered. If you find an incorrect setting, click **Back** to return to the screen containing the error and correct it. When complete, click **Next** to return to the **Check List** dialog box.

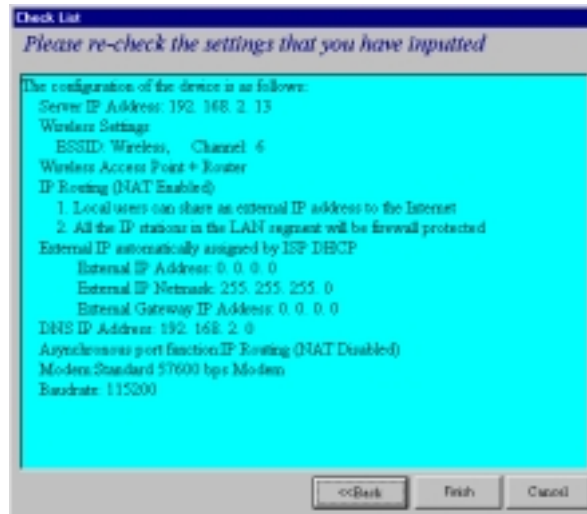

Click **Finish** to complete the configuration.

18. The **Note** dialog box displays indicating that you have completed the Setup Wizard.



Read the **IMPORTANT** information contained in the dialog box. Choose **Run Monitor** (recommended), **Run Manager** or **Exit**.

Testing Your Connection

When you select Run Monitor, the RouteFinder Monitor program loads.

1. To test your current settings, select **Test Connection**. Select **Connect Port 1** to test the WAN port. Select **Connect Port 2** to test the serial async port. The monitor activity will appear in the display window. Refer to the RouteFinder Monitor chapter in this User Guide for additional information about the monitoring capabilities of the RF802EW.
2. After successfully using the Test Connection option in Run Monitor, refer to the LAN Client Settings chapter of this User Guide to continue with your installation by configuring your LAN workstations.

Note: If a problem occurs while testing your connection, or you need to configure more advanced options for your RouteFinder, use RouteFinder Manager by selecting **Programs | RouteFinder Manager | RouteFinder Manager**.

RouteFinder[™]

Chapter 4
Web Browser Configuration
and Management

Chapter 4 - Web Browser Management and Configuration

Using a Web Browser to Configure Your RouteFinder

Launch your Web browser and type the device IP address (**http:// 192.168.2.1**) in the browser's address box. This IP address is the default value of your gateway. Press **Enter**.

Note: Please make sure your PC's address is in the same network as the router's. In Windows 95/98/Me you can type *WINIPCFG*. In Windows 2000/NT, you can type *IPCONFIG*.

The main menu will appear. It displays all of the functions that you can browse, as well as setup for the home Internet gateway.

Navigating - When you click one of the menu buttons at the top of the RouteFinder screen (**Device Information, Device Status, Setup Wizard, Advanced Settings, System Tools, and Help**), the corresponding screen displays. Each screen has a submenu accessed by buttons on the left side of the screen.

RouteFinder Cable/xDSL Wireless Router

SOHO Internet Gateway

DEVICE INFORMATION **DEVICE STATUS** **SETUP WIZARD** **ADVANCED SETTINGS** **SYSTEM TOOLS** **HELP**

SOHO INTERNET GATEWAY RouteFinder

Device Information
Display the device name, IP address, firmware version, and the MAC addresses for the LAN & WAN connections.

Device Status
Check the status of your SOHO Internet Gateway. Check your connection to the Internet and the status of your SOHO internet.

Wireless Settings
Configure ESSID, channel, and encryption for the wireless connection.

Setup Wizard
This is the area where the essential device configuration settings are entered.

Advanced Settings
Device password, LAN DHCP and virtual server settings are configured here.

System Tools
Perform System Tests, reset your gateway, change your password and more with the SOHO Internet Gateway tools.

Help
Get help with commonly asked questions about the SOHO Internet Gateway.

Start the Setup Wizard ▶

Setup Wizard

Use the **Setup Wizard** for a step-by-step process that lets you input all of the basic settings to configure your Router. Click the **Set Wizard** button.



The **Enter Network Password** dialog box displays. Type **admin** (the default user name) in the user name box and leave the password box empty. Click **OK**.

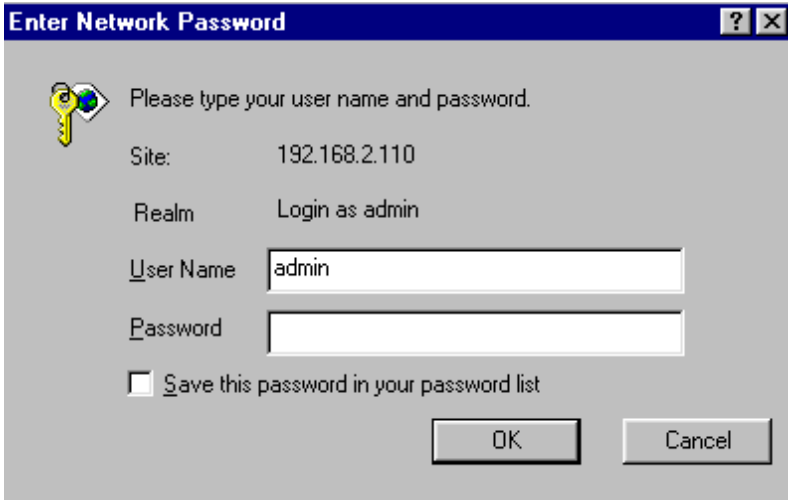

Enter Network Password ? X

Please type your user name and password.

Site: 192.168.2.110

Realm: Login as admin

User Name: admin

Password:

Save this password in your password list

OK Cancel

Note: If you would like to change the password, click the **Advanced Settings** button and choose **Administrative Settings**.

The **Setup Wizard** screen then displays.

Setup Wizard Screen

The screenshot shows the 'RouteFinder' web interface for a 'SOHO Internet Gateway' and 'Cable/xDSL Wireless Router'. The top navigation bar includes 'DEVICE INFORMATION', 'DEVICE STATUS', 'SETUP WIZARD' (highlighted), 'ADVANCED SETTINGS', 'SYSTEM TOOLS', and 'HELP'. A left sidebar menu lists: 'Main menu', 'TIME SETTINGS' (highlighted), 'DEVICE IP SETTINGS', 'CABLE/xDSL ISP SETTINGS', 'ISP ADDITIONAL SETTINGS', 'WIRELESS SETTINGS', 'MODEM SETTINGS', and 'SAVE & RESTART'. The main content area is titled 'TIME ZONE SELECTION' and asks the user to 'Please choose your local time zone:'. A dropdown menu is open, showing '(GMT-04:00) Atlantic Time (Canada)'. A yellow 'NEXT >' button is positioned below the dropdown. Two notes are provided: 'NOTE 1: Please click **'Next'** to enter inputted data.' and 'NOTE 2: Please remember to click **Save & Restart** after you have finished the changes to the device settings.' The footer contains 'Copyright © 2000'.

Setup Wizard - Time Settings

Choose the local time zone (see screen above). After selecting, click the **Next** button to continue to the next step. You can also click the buttons on the left to continue the setup in the order you would like.

Setup Wizard - Device IP Settings

You must give your Internet gateway an IP address on your network. This is not the IP address from your ISP but the local internet LAN IP address. The IP address **192.168.2.1** is the default value of your RF802EW.

Device IP Address

The internal LAN IP address of your Internet gateway.

Device IP Subnet Mask

The subnet mask can usually be left as its default entry **255.255.255.0**.

RouteFinder Cable/xDSL Wireless Router

SOHO Internet Gateway

DEVICE INFORMATION | DEVICE STATUS | **SETUP WIZARD** | ADVANCED SETTINGS | SYSTEM TOOLS | HELP

Main menu

TIME SETTINGS

DEVICE IP SETTINGS

CABLE/xDSL ISP SETTINGS

ISP ADDITIONAL SETTINGS

WIRELESS SETTINGS

MODEM SETTINGS

SAVE & RESTART

DEVICE IP SETTINGS

The device IP address and subnet Mask settings

IP Address: . . .

IP Subnet Mask: . . .

< BACK | NEXT >

NOTE: Please click 'Next' to enter inputted data.

Copyright © 2000

Setup Wizard - ADSL/Cable ISP Settings

If you would like to use ADSL/Cable ISP settings, you have to enable this function by configuring this page. Some ISPs may give you Static IP settings. If this is the case for your ISP, then you need to:

Enter the IP address that is assigned by your ISP.

Enter the IP subnet mask.

Enter the ISP gateway address.

Enter the DNS IP address.

RouteFinder
Cable/xDSL Wireless Router

SOHO Internet Gateway
DEVICE INFORMATION
DEVICE STATUS
SETUP WIZARD
ADVANCED SETTINGS
SYSTEM TOOLS
HELP

Main menu

TIME SETTINGS

DEVICE IP SETTINGS

CABLE/xDSL ISP SETTINGS

ISP ADDITIONAL SETTINGS

WIRELESS SETTINGS

MODEM SETTINGS

SAVE & RESTART

CABLE/xDSL ISP SETTINGS

Your ISP requires you to input IP settings

IP assigned by your ISP: . . .

IP Subnet Mask: . . .

ISP Gateway Address: . . .

Domain Name Server (DNS) IP Address: . . .

< BACK
NEXT >

NOTE: Please click 'Next' to enter inputted data.

Copyright © 2000

Setup Wizard - ISP Additional Settings (PPPoE Settings)

If you would like to use additional ISP settings, you have to enable this function and configure this page. Some ISPs use this protocol for authentication purposes; if this is the case, you need to enter:

User name: Enter the user name of your ISP account.

Password: Enter the password of your ISP account.

Retype password: Enter the password of your ISP account again to re-confirm.

Idle Time: Select the desired idle time: 5, 10, 15, 30, 60, 90, 120 minutes or no idle timeout.

Some ISPs use a Host Name to authenticate the user; if this is the case, you need to enter:

Host Name: Enter the name of the gateway.

Some ISPs require you input the LAN card MAC address; if this is the case, you need to enter:

MAC Address: Enter this LAN card's MAC address.

Note: Some ISPs may recognize your LAN card MAC address as a legal user. In this case, you have to copy the LAN card MAC address in the MAC address field.

For Windows 95/98, you can run **wipnfcfg** to see the LAN card MAC address.

For Windows 2000/NT, you can run **ipconfig/all** to see the LAN card MAC address.

RouteFinder Cable/xDSL Wireless Router

SOHO Internet Gateway

DEVICE INFORMATION | DEVICE STATUS | **SETUP WIZARD** | ADVANCED SETTINGS | SYSTEM TOOLS | HELP

Main menu

TIME SETTINGS

DEVICE IP SETTINGS

CABLE/xDSL ISP SETTINGS

ISP ADDITIONAL SETTINGS

WIRELESS SETTINGS

MODEM SETTINGS

SAVE & RESTART

ISP ADDITIONAL SETTINGS

Your ISP requires you to input username/password (PPPoE Settings)

User Name:

Password:

Retype Password:

Idle Time:

Your ISP requires you to input Host Computer Name

Host Name:

Your ISP requires you to input WAN Ethernet Mac

Mac Address:

NOTE: Please click 'Next' to enter inputted data.

Copyright © 2000

Setup Wizard - Wireless Settings

Use the Wireless Settings screen to enter an ESSID, a channel, and an additional measure of security through the use of encryption.

ESSID - Type a name that you would like to use to identify your secure shell. All wireless work stations must use the same ESSID.

Channel - Select a channel. You may have to try more than one to achieve the best reception.

No Encryption - Selecting this will disable WEP encryption.

64-Bit and 128-Bit Encryption Keys - Enter a valid number for the encryption keys. Valid entries can use digits 0-9 and letters A-F. An encryption key composed entirely of zeroes is not allowed.

Note: These keys have to match the ones at the other location.

RouteFinder Cable/xDSL Wireless Router

SOHO Internet Gateway

DEVICE INFORMATION | DEVICE STATUS | **SETUP WIZARD** | ADVANCED SETTINGS | SYSTEM TOOLS | HELP

Main menu

TIME SETTINGS

DEVICE IP SETTINGS

CABLE/xDSL ISP SETTINGS

ISP ADDITIONAL SETTINGS

WIRELESS SETTINGS

MODEM SETTINGS

SAVE & RESTART

WIRELESS SETTINGS

ESSID:

Channel:

No
 40(64) Bit
 128 Bit

Encryption

Default Key:

Key 1:

Key 2:

Key 3:

Key 4:

< BACK NEXT >

NOTE: Please click 'Next' to enter inputted data.

Setup Wizard - Modem Settings

The modem can be used as a dialup backup to the ADSL/Cable connection. If you would like to use modem backup, you need to enable the modem settings function. Check the box **Dialup Modem When Cable/xDSL is not connected** and input the ISP account settings.

Note: If you change the baud rate settings, please check the initial string. You can refer to your modem manual or TA (Terminal Adapter).

RouteFinder Cable/xDSL Wireless Router

SOHO Internet Gateway

DEVICE INFORMATION | DEVICE STATUS | **SETUP WIZARD** | ADVANCED SETTINGS | SYSTEM TOOLS | HELP

Main menu

TIME SETTINGS

DEVICE IP SETTINGS

CABLE/xDSL ISP SETTINGS

ISP ADDITIONAL SETTINGS

WIRELESS SETTINGS

MODEM SETTINGS

SAVE & RESTART

MODEM SETTINGS

Dialup Modem When Cable/xDSL is not connected

ISP Phone Number:

User Name:

Password:

Retype Password:

Idle Time: 30 minutes

< BACK NEXT >

NOTE 1: Please click 'Next' to enter inputted data.
NOTE 2: Most modems are compatible with standard modem strings. But few modems or ISDN TAs may need special modem string settings. To setup these special modem strings. Please goto Modem Settings in the Advanced Settings.

Copyright © 2000

Setup Wizard - Save and Restart

After you have finished making all the changes on the various pages, click **Save & Restart** to save the settings and restart the device. After the restart, the device will function according to the saved settings.

During the save and restart process, system messages will let you know that you have successfully configured the settings for the device and saved the settings.

During the startup process, the LED of the device will blink. Please **wait** until the blinking of the device stops before proceeding.

Device Information

Click the **Device Information** button when you want to review the device name, IP address, firmware version, and the MAC address for the LAN and WAN connections.

The screenshot displays the RouteFinder web interface. At the top, the title "RouteFinder" is shown in large white letters on a blue background, with "SOHO Internet Gateway" below it. To the right, it says "Cable/xDSL Wireless Router". A navigation bar contains several buttons: "DEVICE INFORMATION" (highlighted in blue), "DEVICE STATUS", "SETUP WIZARD", "ADVANCED SETTINGS", "SYSTEM TOOLS", and "HELP". On the left side, there is a "Main menu" link. The main content area is titled "SOHO INTERNET GATEWAY INFORMATION" and lists the following details:

- Device Name: RF802EW-2
- IP Address: 192.168.2.110
- Private LAN Mac Address: 00:01:09:08:07:06
- Public WAN (Cable/DSL) Mac Address: 00:50:ba:d8:b5:42
- Firmware Version: V4.58 (2001/09/11)

At the bottom of the interface, a blue bar contains the text "Copyright © 2000" on the left and a red circular icon on the right.

Device Status

Click the **Device Status** button when you want to display the current connection status of the Internet gateway.

RouteFinder Cable/xDSL Wireless Router

SOHO Internet Gateway

DEVICES INFORMATION DEVICES STATUS SETUP WIZARD ADVANCED SETTINGS SYSTEM TOOLS HELP

Main menu
WAN Ethernet
 Cable/xDSL: Not Active

RELEASE
 RENEW

Modem Backup:
 Modem: Not Active

Device IP:
 IP: 192.168.2.110
 LAN
 MAC: 00:01:09:08:07:06
 WAN
 MAC: 00:50:ba:d8:b5:42

DHCP LOG

LAN IP: 192.168.2.100 . MAC: 00:c0:6c:00:d9:fd

DEVICE STATUS

modem backup Cable/xDSL Modem

LAN WIRELESS

Modem Backup

The modem can be used as a dialup backup to the ADSL/Cable connection. If the current connection is modem, it will indicate **Modem:Active**. Otherwise, it will indicate **Not Active**.

Device IP

This shows the Device IP address, private LAN MAC address, and public WAN MAC address of the home Internet gateway.

DHCP Log

When you click the DHCP Log button, the Device IP information displays at the bottom of the screen.

Advanced Settings

The **Advanced Settings** screen allows you to set the DHCP server settings, virtual server settings, and password settings.

After clicking the **Advanced Settings** button, the Password dialog box opens. Type **admin** in the user name box. If you left the password field blank, you do not have to type a password.

Advanced Settings - DHCP Server Settings

The home Internet gateway's DHCP server is enabled by default. If you would like to disable it, uncheck the **Enable DHCP Server Functions** box.

RouteFinder Cable/xDSL Wireless Router

SOHO Internet Gateway

DEVICE INFORMATION | DEVICE STATUS | SETUP WIZARD | **ADVANCED SETTINGS** | SYSTEM TOOLS | HELP

Main menu

DHCP SERVER SETTINGS

VIRTUAL SERVER SETTINGS

STATIC ROUTING

DYNAMIC ROUTING

MODEM STRING SETTINGS

ADMINISTRATION SETTINGS

DHCP SERVER SETTINGS

Enable DHCP Server Functions

IP Address Pool Range

From: 192.168.2.

To: 192.168.2.

IP Address Reservation

1. Computer Name:	<input type="text"/>	IP Address:	192.168.2.	<input type="text" value="0"/>
2. Computer Name:	<input type="text"/>	IP Address:	192.168.2.	<input type="text" value="0"/>
3. Computer Name:	<input type="text"/>	IP Address:	192.168.2.	<input type="text" value="0"/>
4. Computer Name:	<input type="text"/>	IP Address:	192.168.2.	<input type="text" value="0"/>

SUBMIT

NOTE: Please click 'Submit' to enter inputted data.

Copyright © 2000

IP Address Pool Range

The IP address pool contains the range of the IP addresses that will automatically be assigned to the clients of your network. The default setting is **192.168.2.2** to **192.168.2.100**.

IP Address Reservation

You can use the IP address reservation option to give particular computers on your network the same static IP address every time the computer is turned on.

Advanced Settings - Virtual Server Settings

Virtual Server Settings allow clients on the Internet to access your LAN via the Internet. You can use the IP mapping function to access an FTP server or Telnet server, etc. on your LAN via your ISP Internet connection. In the **Service** field, type the port number.

RouteFinder
Cable/xDSL Wireless Router

SOHO Internet Gateway
DEVICE INFORMATION
DEVICE STATUS
SETUP WIZARD
ADVANCED SETTINGS
SYSTEM TOOLS
HELP

Main menu

DHCP SERVER SETTINGS

VIRTUAL SERVER SETTINGS

STATIC ROUTING

DYNAMIC ROUTING

MODEM STRING SETTINGS

ADMINISTRATION SETTINGS

VIRTUAL SERVER SETTINGS

1. Internal IP	192.168.2	.	0	Service	<input style="width: 95%;" type="text"/>
2. Internal IP	192.168.2	.	0	Service	<input style="width: 95%;" type="text"/>
3. Internal IP	192.168.2	.	0	Service	<input style="width: 95%;" type="text"/>
4. Internal IP	192.168.2	.	0	Service	<input style="width: 95%;" type="text"/>
5. Internal IP	192.168.2	.	0	Service	<input style="width: 95%;" type="text"/>
6. Internal IP	192.168.2	.	0	Service	<input style="width: 95%;" type="text"/>
7. Internal IP	192.168.2	.	0	Service	<input style="width: 95%;" type="text"/>

SUBMIT

NOTE: Please click '**Submit**' to enter inputted data.

Copyright © 2000

Advanced Settings - Static Routing

Routing is the process of moving a packet of data from source to destination. Use this screen to create a routing table to connect your network to another or to connect subnets within your network.

Enter the routing information, and then click the **Add** button. The routing information will display on the lower portion of the screen. When you have completed the table, click the **Submit** button.

RouteFinder
Cable/xDSL Wireless Router

SOHO Internet Gateway
DEVICE INFORMATION
DEVICE STATUS
SETUP WIZARD
ADVANCED SETTINGS
SYSTEM TOOLS
HELP

Main menu

DHCP SERVER SETTINGS

VIRTUAL SERVER SETTINGS

STATIC ROUTING

DYNAMIC ROUTING

MODEM STRING SETTINGS

ADMINISTRATION SETTINGS

STATIC ROUTING TABLE

Destination IP Address : . . .

Subnet Mask : . . .

Gateway IP Address : . . .

ADD

Del	Destination LAN IP Address	Subnet Mask	Gateway IP Address

SUBMIT

NOTE: Please click 'Submit' to enter inputted data.

Copyright © 2000

Advanced Settings - Dynamic Routing

Dynamic Routing is disabled when Static Routing is used. You will have to disable Static Routing in order to choose one of the dynamic routing protocols (routing protocols that adjust automatically to the changes in the network topology or traffic).

RouteFinder
Cable/xDSL Wireless Router

SOHO Internet Gateway
DEVICE INFORMATION
DEVICE STATUS
SETUP WIZARD
ADVANCED SETTINGS
SYSTEM TOOLS
HELP

Main menu

DHCP SERVER SETTINGS

VIRTUAL SERVER SETTINGS

STATIC ROUTING

DYNAMIC ROUTING

MODEM STRING SETTINGS

ADMINISTRATION SETTINGS

DYNAMIC SETTINGS

SEND Disable RIP1 RIP1 Compatible RIP2

RECEIVE Disable RIP1 Only RIP2 Only Both RIP1/2

SUBMIT

NOTE: Please click 'Submit' to enter inputted data.

Copyright © 2000

Advanced Settings - Modem String Settings

Use the Modem String Settings screen to set the baud rate and any special commands.

The screenshot shows the 'RouteFinder' web interface for a 'SOHO Internet Gateway' and 'Cable/xDSL Wireless Router'. The main navigation bar includes 'DEVICE INFORMATION', 'DEVICE STATUS', 'SETUP WIZARD', 'ADVANCED SETTINGS' (which is highlighted), 'SYSTEM TOOLS', and 'HELP'. A left sidebar menu contains 'Main menu', 'DHCP SERVER SETTINGS', 'VIRTUAL SERVER SETTINGS', 'STATIC ROUTING', 'DYNAMIC ROUTING', 'MODEM STRING SETTINGS' (highlighted in red), and 'ADMINISTRATION SETTINGS'. The main content area is titled 'MODEM SETTINGS' and contains the following fields:

- Baudrate Settings :** A dropdown menu with the selected value '115200bps(28.8K/33/6K/56K modem or ISDN TA)'.
- Pre-Initial String:** A text input field containing 'AT'.
- Initial String:** A text input field containing 'AT S0=1'.
- Dialup String:** A text input field containing 'ATDT'.

A yellow 'SUBMIT' button is located below the input fields. A note at the bottom of the form reads: 'NOTE: Please click **'Submit'** to enter inputted data.'

Copyright © 2000

Advanced Settings - Administrative Settings

Use the Administration Settings screen to change password settings, port numbers, remote user configuration, and system log settings.

RouteFinder
Cable/xDSL Wireless Router

SOHO Internet Gateway
DEVICE INFORMATION
DEVICE STATUS
SETUP WIZARD
ADVANCED SETTINGS
SYSTEM TOOLS
HELP

Main menu

DHCP SERVER SETTINGS

VIRTUAL SERVER SETTINGS

STATIC ROUTING

DYNAMIC ROUTING

MODEM STRING SETTINGS

ADMINISTRATION SETTINGS

PASSWORD SETTINGS

The new password will be used to authenticate the user when configuring the device.

New Password:

Retype Password:

SYSTEM ADMINISTRATION

HTTP Port No:

Telnet Port No:

Allow remote user to configure the device

Remote administration host

IP Address: . . .

Allow remote user to ping the device

SYSTEM Log

Enable System Log Function

Log server IP address . . .

SUBMIT

NOTE 1: Please click '**Submit**' to enter inputted data.
NOTE 2: This function will enable the system log daemon to log all the system information to the system log server.

System Tools

Use the System Tools screen to view the Intruder Detection Log, view the Routing Table, and run a System Diagnosis.

System Tools - Intruder Detection Log

The event messages show the possible hacker attacks that have occurred on your Internet gateway. Up to 32 hacker attacks may be logged in this manner.

The screenshot shows the RouteFinder web interface for a SOHO Internet Gateway. The main navigation bar includes links for DEVICE INFORMATION, DEVICE STATUS, SETUP WIZARD, ADVANCED SETTINGS, SYSTEM TOOLS, and HELP. The SYSTEM TOOLS menu is active, and the INTRUDER DETECTION LOG page is displayed. The page features a main menu on the left with buttons for INTRUDER DETECTION LOG, DISPLAY ROUTING TABLE, SYSTEM DIAGNOSTICS, LOAD DEFAULT SETTINGS, UPGRADE FIRMWARE, and RESET DEVICE. The central area displays the INTRUDER DETECTION LOG with a table header.

Index	Time	Protocol	Source IP (Port)	Dest IP (Port)	Event

Copyright © 2000

System Tools - Display Routing Table

Use this screen to view the current routing information.

RouteFinder Cable/xDSL Wireless Router
SOHO Internet Gateway

[DEVICE INFORMATION](#)
[DEVICE STATUS](#)
[SETUP WIZARD](#)
[ADVANCED SETTINGS](#)
[SYSTEM TOOLS](#)
[HELP](#)

Main menu

INTRUDER DETECTION LOG

DISPLAY ROUTING TABLE

SYSTEM DIAGNOSTICS

LOAD DEFAULT SETTINGS

UPGRADE FIRMWARE

RESET DEVICE

DISPLAY ROUTING TABLE

Type	Destination LAN IP Address	Subnet Mask	Gateway IP Address	Hop Count
INTF	192.168.2.0	255.255.255.0	192.168.2.110	1

Copyright © 2000

System Tools - System Diagnosis

Use the **System Diagnosis** screen to view your Internet gateway's information. This information can help you check-up on your Internet gateway to make sure that everything is functioning properly or, under the diagnosis section, to check the device and the link status to see that it's working.

RouteFinder SOHO Internet Gateway

DEVICE INFORMATION | DEVICE STATUS | SETUP WIZARD | ADVANCED SETTINGS

Main menu

- INTRUDER DETECTION LOG
- DISPLAY ROUTING TABLE
- SYSTEM DIAGNOSTICS**
- LOAD DEFAULT SETTINGS
- UPGRADE FIRMWARE
- RESET DEVICE

SYSTEM DIAGNOSIS

Configuration

Firmware Version: V4.58

ISP Settings

IP assigned method: Statically assigned
 IP address: 0.0.0.0
 Gateway IP address: 0.0.0.0
 DNS Server IP address: 0.0.0.0
 Host Name: RF802EW-2
 PPPoE Enable : No
 PPPoE Username:

Modem Settings

Telephone Number:
 Dial-up User Name:
 Idle Timeout: 30 minutes
 Pre Initial String: AT
 Initial String: AT S0=1
 Dialup String: ATDT

Device Settings

Device IP address as:
 Device Network Mask:
 DHCP Server: Enabled
 Pool from: 192.168.2.2
 Pool to: 192.168.2.100

Diagnosis

ISP Status

Cable / xDSL IP address: 0.0.0.0
 DNS IP address: 0.0.0.0
 Modem (async) IP address: 0.0.0.0

Link Status

Cable/xDSL	Disconnected
LAN	Connected
Modem	Modem is Not Ready

Current WAN connection

Cable/xDSL	Not Connected
------------	---------------

LAN MAC Table

LAN IP: 192.168.2.100 . MAC: 00:c0:6c:00:d9:fd

WAN MAC Table

System Tools - Load Default Settings

Use this screen to load the original default settings of your Internet gateway.

The screenshot displays the 'RouteFinder' web interface for a 'SOHO Internet Gateway' (Cable/xDSL Wireless Router). The interface features a top navigation bar with the following tabs: DEVICE INFORMATION, DEVICE STATUS, SETUP WIZARD, ADVANCED SETTINGS, SYSTEM TOOLS, and HELP. On the left side, there is a 'Main menu' with several buttons: INTRUDER DETECTION LOG, DISPLAY ROUTING TABLE, SYSTEM DIAGNOSTICS, LOAD DEFAULT SETTINGS (highlighted in red), UPGRADE FIRMWARE, and RESET DEVICE. The main content area is titled 'LOAD DEFAULT SETTINGS' and contains the following text: 'Load Default Settings will load the factory default settings for the device. Please click on the START button to proceed.' Below this text is a note: 'Note. The Device IP Address will be reset to 192.168.2.1 after Load Default.' At the bottom of the main content area, there are two buttons: 'START' and 'CANCEL'. The footer of the interface shows 'Copyright © 2000'.

System Tools - Upgrade Firmware

Use this screen to upgrade the newest firmware to your RF802EW at MultiTech.com

The screenshot shows the 'RouteFinder' web interface for a 'SOHO Internet Gateway' (Cable/xDSL Wireless Router). The main navigation bar includes 'DEVICE INFORMATION', 'DEVICE STATUS', 'SETUP WIZARD', 'ADVANCED SETTINGS', 'SYSTEM TOOLS', and 'HELP'. The 'SYSTEM TOOLS' menu is expanded, showing options like 'INTRUDER DETECTION LOG', 'DISPLAY ROUTING TABLE', 'SYSTEM DIAGNOSTICS', 'LOAD DEFAULT SETTINGS', 'UPGRADE FIRMWARE', and 'RESET DEVICE'. The 'UPGRADE FIRMWARE' option is highlighted in red. The main content area is titled 'FIRMWARE UPGRADE' and contains instructions: 'Enter the firmware file path into the box and click START to proceed with the new firmware upgrade.' Below this is a text input field labeled 'Firmware Upgrade File:' with a 'Browse...' button to its right. A yellow 'START' button is positioned below the input field. The footer of the interface displays 'Copyright © 2000'.

RouteFinder Cable/xDSL Wireless Router

SOHO Internet Gateway

DEVICE INFORMATION DEVICE STATUS SETUP WIZARD ADVANCED SETTINGS SYSTEM TOOLS HELP

Main menu

INTRUDER DETECTION LOG

DISPLAY ROUTING TABLE

SYSTEM DIAGNOSTICS

LOAD DEFAULT SETTINGS

UPGRADE FIRMWARE

RESET DEVICE

FIRMWARE UPGRADE

Enter the firmware file path into the box and click START to proceed with the new firmware upgrade.

Firmware Upgrade File: Browse...

START

Copyright © 2000

System Tools - Reset Device

Use this screen to reset your RouteFinder. Reset your RouteFinder when changing settings. Resetting the RouteFinder will restart it. Click the **Start** button to reset the device.

The screenshot displays the RouteFinder web interface. At the top, the title 'RouteFinder' is shown in large blue letters, with 'SOHO Internet Gateway' and 'Cable/xDSL Wireless Router' on either side. Below the title is a navigation bar with tabs for 'DEVICE INFORMATION', 'DEVICE STATUS', 'SETUP WIZARD', 'ADVANCED SETTINGS', 'SYSTEM TOOLS', and 'HELP'. The 'SYSTEM TOOLS' tab is currently selected. On the left side, there is a 'Main menu' with several buttons: 'INTRUDER DETECTION LOG', 'DISPLAY ROUTING TABLE', 'SYSTEM DIAGNOSTICS', 'LOAD DEFAULT SETTINGS', 'UPGRADE FIRMWARE', and 'RESET DEVICE'. The 'RESET DEVICE' button is highlighted in red. The main content area is titled 'RESET THE DEVICE' in green text. Below the title, a message states: 'Resetting the device will restart it. Please click on the START button to proceed.' At the bottom of the main content area, there are two buttons: 'START' and 'CANCEL', both in yellow with black text. The footer of the page contains the text 'Copyright © 2000' on the left and a red circular icon on the right.

RouteFinder[™]

Chapter 5
Telnet

Chapter 5 - Using Telnet to Configure Your RouteFinder

Telnet is a telecommunications software utility which allows you to access a remote device. The RouteFinder RF802EW has a built-in Telnet Server that enables a Telnet client to remotely configure the device using a menu system.

Important: Non-Windows operating system users must use the Telnet menu system to define the function of the WAN and async ports, to define how IP addresses are administered, to configure IP addresses on your local and remote systems and to set up any necessary virtual server, routing table and packet filtering options.

Note: To successfully configure your router using Telnet, TCP/IP must be correctly configured on your computer. The router and computer must also be located on the same subnet.

Starting a Telnet Session

1. Start your telnet session and connect to the RouteFinder RF802EW using the router's default IP address of 192.168.2.1 and vt100 terminal emulation.

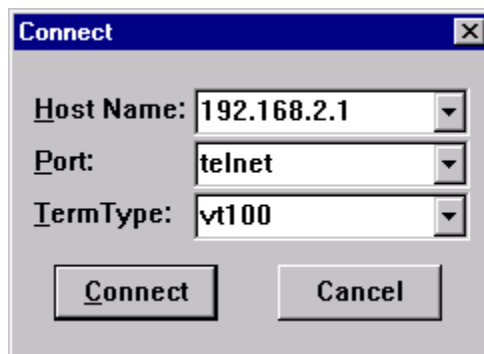

If you are using a graphical interface such as the one shown above, click **Connect**.

2. When prompted to input the Router Password, press **Enter**.
3. The RF802EW Telnet Server Menu displays.

```
Please input ROUTER password
Password:

ROUTER SETTINGS
a). ROUTER IP ADDRESS           <169.254.178.10>
b). ROUTER SUBNET MASK         <255.255.255.0>
c). ROUTER NAME                 <RF802EW>
d). ROUTER PASSWORD            <>
e). WAN ETHERNET MAC ADDR.     <00:50:8A:D8:B5:42>
f). WAN ETHERNET SETTINGS     <INTERNET ACCESS>
g). ASYNC PORT SETTINGS        <REMOTE ACCESS>
h). WIRELESS SETTINGS
i). ROUTER DNS IP ADDRESS      <0.0.0.0>
j). LAN DHCP SERVER            <ENABLE>
k). VIRTUAL SERVER              <DISABLE>
l). ROUTING TABLE
m). CLIENT FILTER SETTINGS
n). LOAD DEFAULT SETTINGS
o). SAVE AND RESTART SERVER
p). DIAGNOSTIC
q). QUIT
Select ? █
```

To use the menu, type the letter corresponding to the parameter you'd like to change.

Depending on the parameter you are changing, you are presented with an open field into which you may type new information, or you are presented with a list of options from which you may select a value. Each menu item is described in the following pages.

Note: After entering parameters for all settings that you want to change, continue to type **q** to return to the previous menu until you reach the main Telnet Server menu. Select Save and Restart Server to save your new configuration.

Server Menu Options

a). Router IP Address

Enter the IP address assigned to the RF802EW on your local network. The new address will take effect after you have selected **Save and Restart Server**.

b). Router Subnet Mask

Enter the subnet mask for your local network.

c). Router Name

Enter a network name for the RF802EW. If your ISP requires your device to have a name, you may use the value entered in this field.

d). Router Password

The default is no password. If you choose to use a password, ensure that you write the password down and keep it in a safe place. If you forget the password, contact the Multi-Tech Technical Support for assistance. Refer to Chapter 10 in this User Guide for contact information.

e). WAN Ethernet MAC Addr.

Displays the current MAC address of your router. Edit this only if required by your remote system or ISP.

f). WAN Ethernet Settings

Define the function of the WAN port by selecting Internet Access (IP Routing-NAT Enabled) or LAN-to-LAN access (IP Routing-NAT Disabled). Refer to the WAN Ethernet Segment section of the RouteFinder Manager chapter for more information.

```
f). WAN Ether  SETTINGS                <INTERNET ACCESS>
FUNCTION SETTING
a). INTERNET ACCESS
b). LAN-to-LAN ACCESS
Select ? █
```

Internet Access

If you use the WAN port for Internet Access, you must configure the following options:

```
INTERNET ACCESS PORT SETTING
a). WAN ETHERNET PORT IP ADDRESS      <0.0.0.0>
b). WAN ETHERNET PORT IP NETMASK     <255.255.255.0>
c). WAN ETHERNET GATEWAY IP ADDRESS  <0.0.0.0>
d). PPPoE                             <ENABLE>
e). PPPoE USER NAME                  <>
f). PPPoE PASSWORD                   <>
q). PREVIOUS MENU                    <>
Select ?
```

Enter the IP port information provided by your ISP or other external network administrator.

Note: If your ISP uses dynamic IP addressing, leave the External Port IP address and External Gateway IP address at the default values of 0.0.0.0. Set the External IP Netmask to the default value of 255.255.255.0.

LAN-to-LAN Access

To use the WAN port to connect to another LAN, you must configure the following:

LAN to LAN PORT SETTING

- a). WAN ETHERNET PORT IP ADDRESS <0.0.0.0>
 - b). WAN ETHERNET PORT IP NETMASK <255.255.255.0>
 - q). PREVIOUS MENU
- Select ?

Enter the IP and Netmask address of the network to which you are connecting.

g). Async Port Settings

The async port may be used for **IP Routing** or **Remote Access**. For more information, see the Async Port section of the RouteFinder Manager chapter.

IP Routing

If you will use the async port for IP Routing, enter the following information as described:

- ```

IP ROUTING PORT SETTING
a). TELEPHONE NUMBER <>
b). USER NAME <>
c). PASSWORD <>
d). IDLE TIMEOUT <5>
e). SERIAL BAUDRATE <115200>
f). MODEM PRE-INITIAL STRING <AT>
g). MODEM INITIAL STRING <AT S0=1>
h). MODEM DIALUP STRING <ATDT>
i). MODEM HANGUP STRING <ATH0>
j). LOGIN SCRIPT <DISABLE>
k). EDIT LOGIN SCRIPT
l). EXTERNAL IP ADDRESS <0.0.0.0>
m). NAT FUNCTION <ENABLE>
n). ASSIGN REMOTE IP <DISABLE>
q). PREVIOUS MENU
Select ?

```

#### Telephone Number

Enter the phone number the async device must dial to connect to the remote system.

#### User Name

Enter the User Name that will be used for authentication on the remote system.

#### Password

Enter the Password associated with the User Name for the remote system.

#### Idle Timeout

Enter the amount of idle time allowed to pass before the connection times out. The default value is 5 minutes.

#### Serial Baudrate

Use the list to select the appropriate baudrate of the modem attached to your async port. You may need to select a lower speed to ensure a quality connection.

#### Modem Pre-Initial String

Consult your modem or ISDN TA User Guide for this information. The default value will work for most analog modems.

#### Modem Initial String

Consult your modem or ISDN TA User Guide for this information.

#### Modem Dialup String

Consult your modem or ISDN TA User Guide for this information.

#### Modem Hangup String

Consult your modem or ISDN TA User Guide for this information.

**Login Script**

Select Enable or Disable.

**Edit login Script**

Refer to the RouteFinder Manager chapter of this User Guide for information on editing scripts.

**External IP Address**

Enter the IP address of the remote device to which you are connecting.

**NAT Function**

Select Enable or Disable. Refer to the Glossary in this User Guide for additional information on NAT.

**Assign Remote IP**

Select Enable or Disable. If you select Enable, you will be prompted to enter an address to be assigned to the remote system.

**Remote Access**

To configure the async port for Remote Access, enter values for each of the following:

|                                   |                         |
|-----------------------------------|-------------------------|
| <b>REMOTE ACCESS PORT SETTING</b> |                         |
| a). IP ASSIGNED METHOD            | <AUTOMATICALLY>         |
| b). PROTOCOLS                     | <BOTH IP & IPX ENABLED> |
| c). IPX/SPX FRAME TYPE            | <AUTODETECT>            |
| d). AUTHENTICATION METHOD         | <PAP>                   |
| e). EDIT USER DATABASE            |                         |
| f). IDLE TIMEOUT                  | <0>                     |
| g). SERIAL BAUDRATE               | <115200>                |
| h). MODEM PRE-INITIAL STRING      | <AT>                    |
| i). MODEM INITIAL STRING          | <AT S0=1>               |
| j). MODEM DIALUP STRING           | <ATDT>                  |
| k). MODEM HANGUP STRING           | <ATH0>                  |
| l). EDIT LOGIN SCRIPT             |                         |
| m). RADIUS SERVER                 | <ENABLE>                |
| n). RADIUS ACCESS SERVER IP       | <0.0.0.0>               |
| o). RADIUS ACCOUNTING SERVER IP   | <0.0.0.0>               |
| p). RADIUS SECRET                 | <>                      |
| q). PREVIOUS MENU                 |                         |

**IP Assigned Method**

Select the method the client will use to have their IP address assigned.

**Protocols**

Default value is **Both IP and IPX enabled**. You may select to use only one protocol, however if you are connecting to a Netware server, you must have IPX enabled.

**IPX/SPX Frame Type**

The default value is **Autodetect**. If you have problems with your network connection, you may select Ethernet\_II, Ethernet\_802.3, Ethernet 802.2 or Ethernet\_snap.

**Authentication Method**

Select either None, PAP or CHAP. Refer to the RouteFinder Manager chapter of this User Guide for additional information.

**Edit User Database**

To add users to the database, select the next available letter. Enter the User Name, Password and Callback type for each user that you add to the database. You may enter up to 64 remote clients.

**Idle Timeout**

The default value is 5 minutes.

**Serial Baudrate**

Select one of the available options. You may need to use a slower speed to ensure a quality connection.

**Modem Pre-initial string**

Refer to your modem or ISDN TA User Guide for information. The default value will work for most analog modems.

**Modem Initial string**

Refer to your modem or ISDN TA User Guide for information.

**Modem Dialup string**

Refer to your modem or ISDN TA User Guide for information.

**Modem Hangup string**

Refer to your modem or ISDN TA User Guide for information.

**Edit login script**

Select this option to edit the login script executed when the client connects to the network. Refer to the RouteFinder Manager chapter of this User Guide for additional information about creating and editing scripts.

**RADIUS Server**

Select *Enable* to configure remote users to authenticate on a RADIUS Server.

**RADIUS Access Server IP**

Enter the IP address of the RADIUS Access server.

**RADIUS Accounting Server IP**

Enter the IP address of the RADIUS Accounting server. In most configurations, the Access and Accounting server are located on the same machine, so the IP address is the same for both.

**RADIUS Secret**

Enter the secret code or password for the RADIUS Server.

## h.) Wireless Settings

Enter an ESSID, select a channel, and set encryption keys on this screen.

**ESSID**

Type a name that you would like to identify your secure shell. All wireless work stations must have the same ESSID.

**Channel**

Select a channel. You may have to try more than one to achieve the best reception.

**Enable/Disable**

Choose to enable or disable WEP encryption.

**WEP Keys**

If you enable WEP encryption, you enter 64-bit encryption keys and 128-bit encryption keys. Valid entries can use digits 0-9 and letters A-F. An encryption key composed entirely of zeros is not valid.

**Note:** The keys have to match at both locations.

## i). Router DNS IP Address

Enter the IP address of your Internet Service Provider's DNS server.

## j). DHCP Server

You may select **Disable** or **Enable**. If you would like the RF802EW DHCP server function to provide IP information to workstations as they connect to the network, select **Enable**. When you enable DHCP, you will be prompted to provide the beginning and ending IP addresses in the range of addresses administered by your RouteFinder. Refer to the LAN DHCP section of the RouteFinder Manager chapter of this User Guide for additional information.

## k). Virtual Server

Select **Disable** or **Enable**. If you select **Enable**, you may enter the external and internal IP Addresses necessary to allow remote clients to access specific devices on your network via the Internet. Refer to the General Settings section of the RouteManager chapter in this User Guide for more information about Enabling IP Mapping.

**l). Routing Table**

The Routing Table option lets you create a routing table so your RouteFinder will route IP packets to the proper network. For more information, refer to the Routing Table section of the RouteFinder Manager chapter of this User Guide.

**m). Client Filter Settings**

The Filter Settings option allows you to define which packets are allowed to either pass through, or be blocked from passing through the RF802EW ports. You may filter packets for network services including Mail, WWW, FTP, Telnet and News. See the Filter Settings section of the RouteFinder Manager chapter for more information about filtering options.

**n). Load Default Settings**

Use this option to return the router to the factory default settings.

**o). Save and Restart Server**

This option saves your RouteFinder configuration into Flash memory and restarts the device to enable the settings to take effect. The system will pause while settings are being saved.

**Note:** After completing your configuration, you must select Save and Restart Server or your settings will be lost when power is turned off for the device.

**p). Diagnostic**

The Diagnostic option performs basic testing of the RouteFinder, displays information about your firmware and offers options for assigning the LAN and WAN MAC addresses as may be required by your ISP.

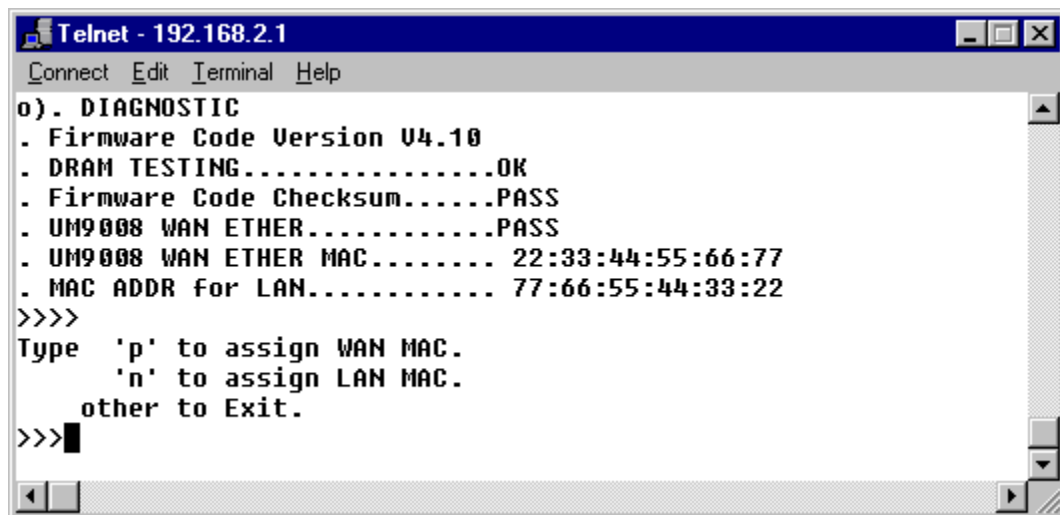

```

Telnet - 192.168.2.1
Connect Edit Terminal Help
o). DIAGNOSTIC
. Firmware Code Version U4.10
. DRAM TESTING.....OK
. Firmware Code Checksum.....PASS
. UM9008 WAN ETHER.....PASS
. UM9008 WAN ETHER MAC..... 22:33:44:55:66:77
. MAC ADDR for LAN..... 77:66:55:44:33:22
>>>>
Type 'p' to assign WAN MAC.
 'n' to assign LAN MAC.
 other to Exit.
>>>

```

Type any key to return to the main menu.

**q). Quit**

---

*RouteFinder*<sup>™</sup>

**Chapter 6**  
**RouteFinder Manager**

## Chapter 6 - RouteFinder Manager

### Accessing the RouteFinder Manager Software

RouteFinder manager is the main program used to configure all the settings of your RF802EW.

1. To run RouteFinder Manager, double-click the **RouteFinder Manager** icon on your desktop, or click **Start | Programs | RouteFinder Manager | RouteFinder Manager**.
2. The **Manager** dialog box displays.

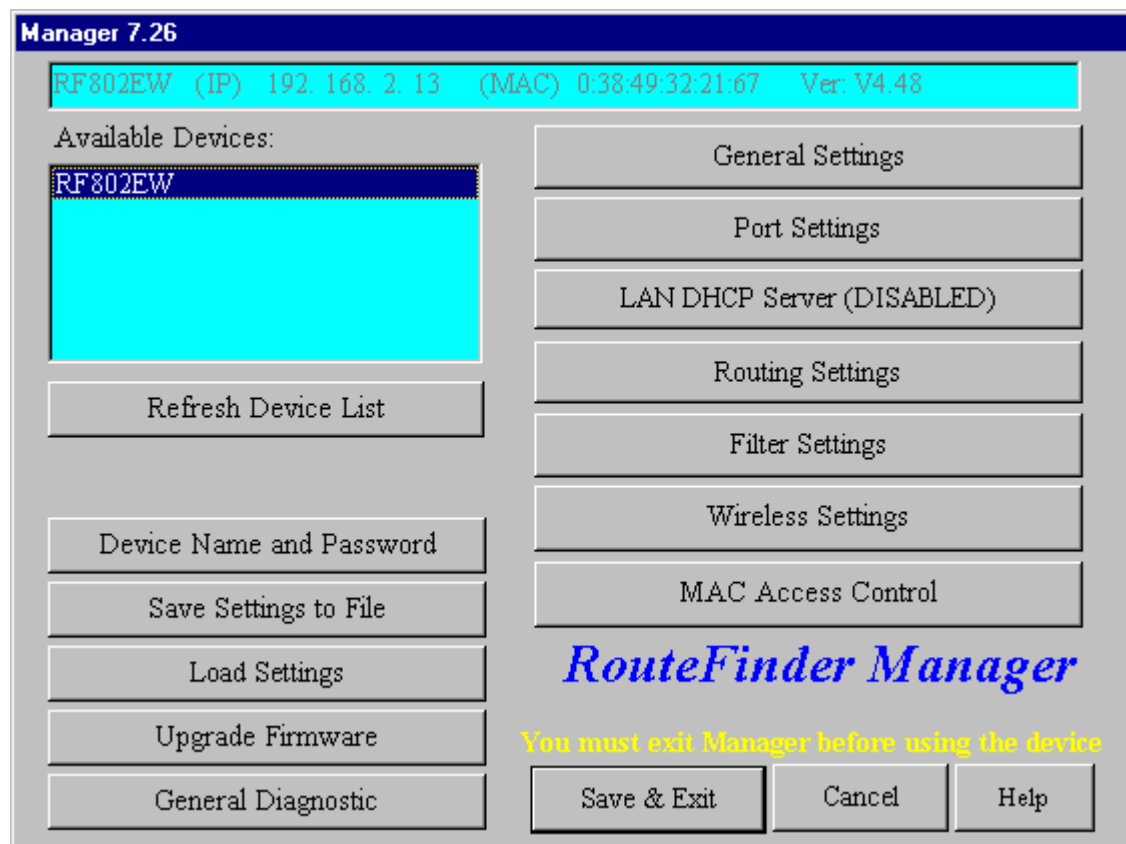

3. The RF802EW automatically searches your network for devices available for configuration and displays them in the **Available Devices** list box.

Select the device you are attempting to configure from the **Available Devices** list. If you need to update the list, click **Refresh Device List**. You must exit RouteFinder Manager before using the device.

After you have selected a device from the **Available Devices** list, the **Status** box at the top of the screen provides the following information about your device: name, IP address, MAC address, and firmware version number of your RouteFinder.

## Description of the RouteFinder Manager Main Screen

### Buttons on the Left Side of the Screen

The buttons in the left column offer the ability to change the device's name and password, save and load settings, upgrade the firmware or run general diagnostics on the device.

### Available Devices

The RF802EW automatically searches your network for devices available for configuration and displays them in the **Available Devices** list box.

### Refresh Device List

If a device does not appear in the list, click **Refresh Device List** again to determine if the device will appear on the list. If the device still does not appear, ensure that all cables are correctly connected and that the power to the RF802EW is turned on. If the device still does not appear in the list, refer to the Troubleshooting chapter of this User Guide.

### Device Name and Password

You may use the default device name or use this dialog box to change the name or add a password for your device.

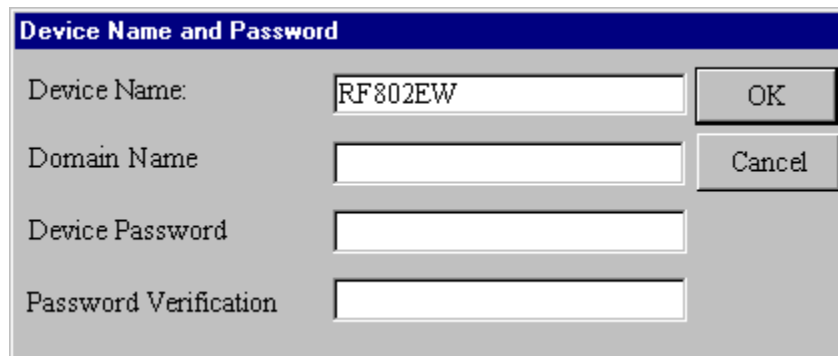

The screenshot shows a dialog box titled "Device Name and Password". It features four text input fields stacked vertically. The first field, labeled "Device Name:", contains the text "RF802EW". The second field is labeled "Domain Name". The third field is labeled "Device Password". The fourth field is labeled "Password Verification". To the right of the "Device Name" field is an "OK" button, and to the right of the "Domain Name" field is a "Cancel" button.

**Device Name** - Displays the name of your network device. To change the name, simply enter a new name. If you are connecting to an ISP via cable modem or DSL, and your ISP requires you to enter a computer name, you may use the device name that you entered here.

**Domain Name** - Enter your local network domain name.

**Device Password** -The RouteFinder manager does not come with a default password. If you enter a password, you will be prompted to enter the password each time you want to configure your network device. To enter a Password, type your password in the **Device Password** box, then re-enter your password in the **Password Verification** box.

**Note:** Entering a password is strongly recommended to protect your RouteFinder from unauthorized reconfiguration. If you enter a password, ensure you have selected something that will be easy to remember or write it down and store it in a safe location. If you have completely forgotten your password, contact Multi-Tech Technical Support for assistance. Refer to Chapter 10 in this User Guide for more information about our Technical Support services.



## Save Settings to File

This option allows you to save your settings to a file. This option provides a method for backing up your system configuration so that it can be used in the event your settings become accidentally deleted. This option can also be used if you would like to have more than one set of settings for your RouteFinder.

1. From the main **Manager** dialog box, click **Save Settings to File**.
2. The **Save Settings to File** dialog box displays.

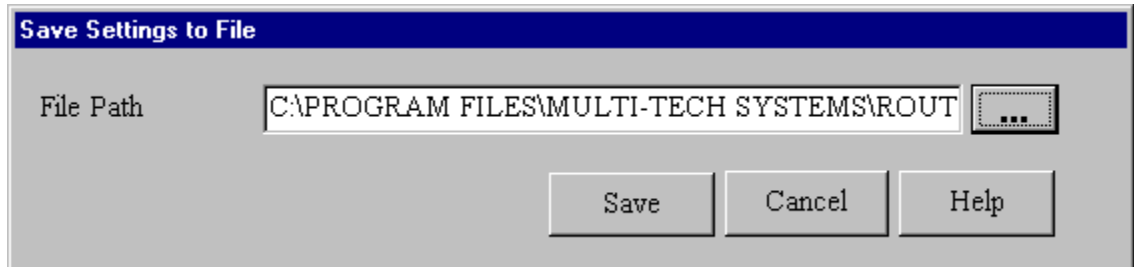



3. In the **File Name** box, enter the full path of the file containing the settings you want to use or click  then navigate to and select the file. You can save a copy of the file in a different location by changing the path.
4. Click **OK** to save the settings to the file.

## Load Settings

This option allows you to load either the default settings of your network device or to load settings previously saved to a file.

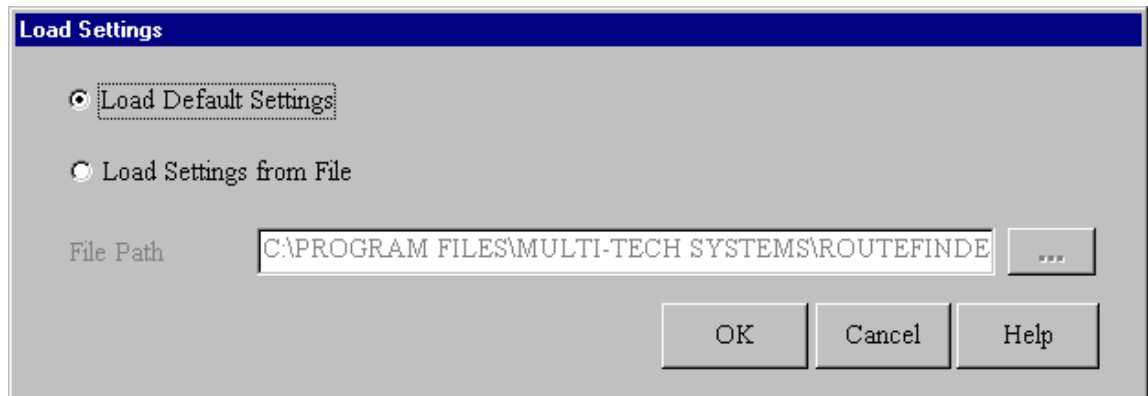
1. From the main **Manager** dialog box, click **Load Settings**.
2. The **Load Settings** dialog box displays.



3. To return the RouteFinder to factory default settings, select **Load Default Setting**.
4. To load a configuration from a file, select **Load Settings From File**.
5. In the **File Path** box, enter the name of the file containing the settings you would like to use or click  then navigate to and select the file.
6. Click **OK** to load and apply the settings to the RouteFinder.

## Upgrade Firmware

This options allow you to upgrade your RF802EW firmware. It upgrades the firmware of your RF802EW, not the RouteFinder Manager or Monitor software.

**Warning:** Upgrade the firmware of your RouteFinder RF802EW only under the advice and direction of the Multi-Tech Technical Support Group. Improperly upgrading the RF802EW may disable the device!

1. From the main **Manager** dialog box, click **Upgrade Firmware**.
2. The **Upgrade Firmware** dialog box displays.

The screenshot shows a dialog box titled "Upgrade Firmware". It contains four text input fields and three buttons. The fields are: "Current Device Version" with the value "V4.48", "Firmware File Name" with the value "RF800", "Firmware File Directory" with the value "C:\PROGRAM FILES\MULTI-TECH SYSTEMS\ROUTEFIND", and "Firmware File Version" with the value "V4.48". The buttons are "Upgrade", "Cancel", and "Help". A large yellow shaded area is at the bottom of the dialog box.

3. Download the latest firmware from the Multi-Tech System's web site at [www.multitech.com](http://www.multitech.com).
4. Copy the firmware to the directory containing the RouteFinder Manager program files. Refer to the default **Firmware File Directory** box to determine the location of the files on your system.
5. Enter the location of the new firmware file in the **Firmware File Directory** box. RouteFinder Manager will automatically detect the new firmware file name and display it in the **Firmware File Name** box. The version number of your firmware will display in the **Firmware File Version** box.
6. Click **Upgrade** to upgrade your firmware.
7. A message displays stating the upgrade has started.
8. After several minutes, an informational dialog box displays indicating the upgrade was successful.
9. Click **OK**.
10. From the main **Manager** dialog box, click **Save and Exit**.
11. Click **Yes** to restart the RouteFinder using the new firmware version.

## General Diagnostic

This option displays network device information and allows you to determine if the RF802EW is functioning properly.

1. From the main **Manager** dialog box, click **General Diagnostic**.
2. The **General Diagnostic** dialog box displays information about the RF802EW.

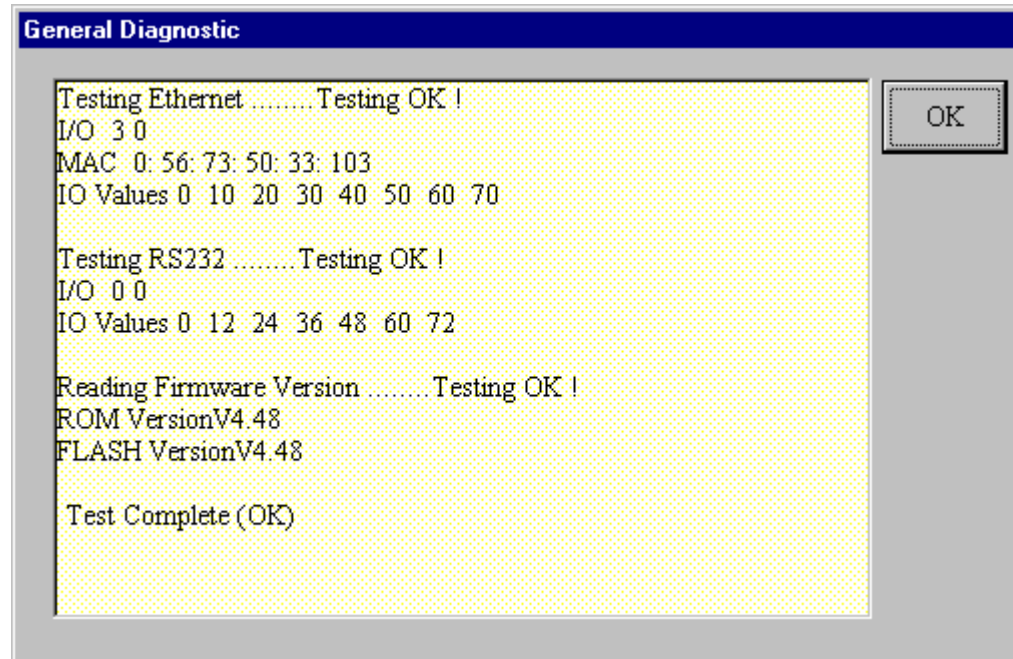

3. Record the information if necessary and click **OK** to exit.

## Buttons on the Right Side of the Screen

The buttons in the right column provide access to advanced configuration options for General Settings, Port Settings, LAN DHCP Server Options, Router Settings, and Filter Settings. These are described in detail on the following pages.

## General Settings Option on the Manager Main Screen

After selecting your device from the **Available Devices** list, click **General Settings** to view or change all of the major network settings for the RF802EW including LAN and WAN Ethernet segment settings, DNS information, IP Routing, and Remote Access settings. Most of the settings here were entered in Setup Wizard. However, some important settings can be entered only in RouteFinder Manager.

This **Wireless Point Settings** dialog box displays first.

**Enable Access Point + Router function** is the default option. This allows you to setup your network connection and routing.

If **Enable Access Point function only** is selected, you can set the Access Point's IP as manual settings or acquire an IP address from a DHCP server. This allows you to setup your network connection without routing.

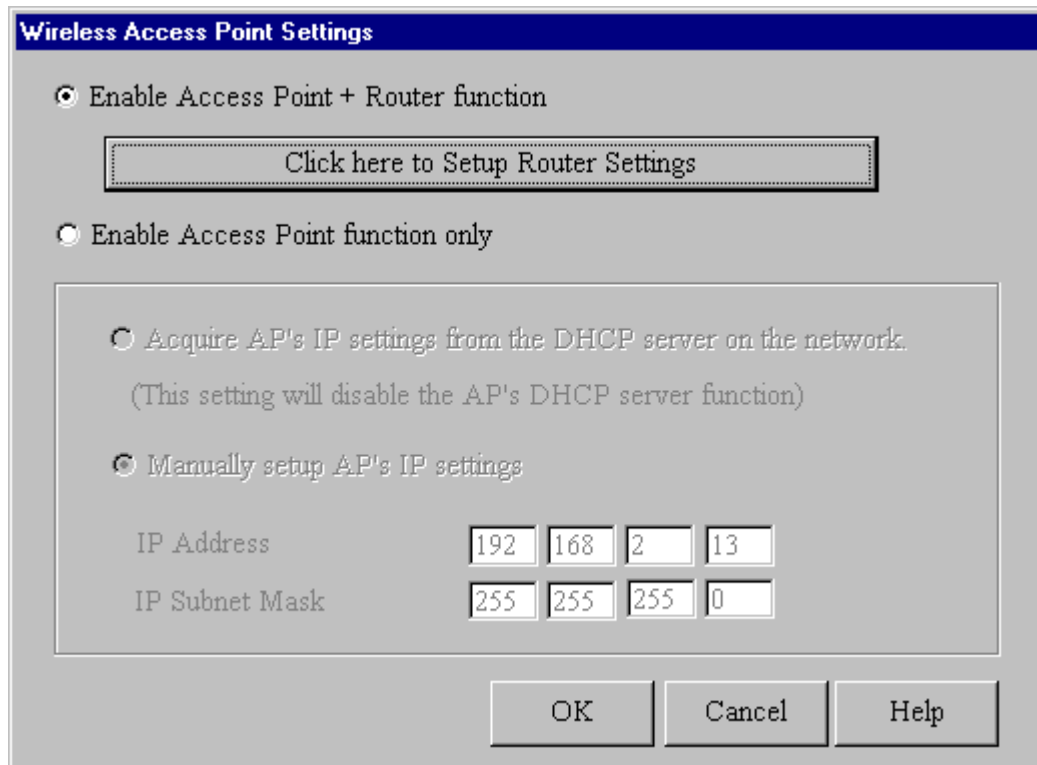

The dialog box titled "Wireless Access Point Settings" contains the following elements:

- Two radio buttons at the top:
  - Enable Access Point + Router function
  - Enable Access Point function only
- A button labeled "Click here to Setup Router Settings" located below the first radio button.
- A sub-dialog box containing:
  - Acquire AP's IP settings from the DHCP server on the network.  
(This setting will disable the AP's DHCP server function)
  - Manually setup AP's IP settings
  - Input fields for IP Address: 192, 168, 2, 13
  - Input fields for IP Subnet Mask: 255, 255, 255, 0
- Buttons for "OK", "Cancel", and "Help" at the bottom right.

Click **Click here to Setup Router Settings** to select Router settings for your RouteFinder.

The **General Settings** dialog box contains settings for IP information for LAN Ethernet Segment and WAN Ethernet Segment, DNS number, IP Routing settings, and Remote Access settings.

**General Settings**

**LAN Ethernet Segment**

Server IP Address: 192 168 2 13

Server IP Netmask: 255 255 255 0

**WAN Ethernet Segment**

NAT (Network Address Translation)

PPPoE

User Name: \_\_\_\_\_

Password: \_\_\_\_\_

External Port IP Address: 0 0 0 0

External Port IP Netmask: 255 255 255 0

Gateway IP Address: 0 0 0 0

\*Note : Wan Ethernet Port IP Address : 0.0.0.0 indicates assigned by remote server

**Async Port**

IP Routing  Remote Access

PPP Settings Remote Access Settings

Enable IP Mapping IP Mapping (Virtual Server)

OK Cancel Help

## General Settings Options

### LAN Ethernet Segment

**Server IP address** - This IP address is the internal LAN IP address of the RF802EW. The address entered into the Setup Wizard is displayed here (for example, 192.168.2.1).

**Server IP Netmask** -The RF802EW subnet mask generally can be left at the default value of 255.255.255.0.

### WAN Ethernet Segment

Select **NAT (Network Address Translation)** to provide firewall protection and enable all local LAN users to share one IP address to access the Internet. If the NAT box is not selected, the WAN Ethernet is configured as a router to route network traffic between the LAN Ethernet segment and the WAN Ethernet segment. The External Port IP Addresses are provided by your ISP or remote system administrator.

**PPPoE** - If your ISP uses Point-to-Point Protocol over Ethernet for authentication purposes, select the PPPoE box and enter your ISP account User Name and Password.

**External Port IP Address** - Enter the IP address provided by your ISP or remote system administrator.

**External Port IP Netmask** - Enter the subnet mask of the port as provided by your ISP or remote system administrator.

**Gateway IP Address** - Enter your ISP or remote network's Gateway IP address.

**Note:** If your ISP uses a DHCP server to automatically assign a login IP address, subnet mask, gateway IP address or DNS IP address, enter 0.0.0.0 as your External Port IP Address and the Gateway IP Address.

## Async Port

The Async Port can be configured to provide either IP Routing or Remote Access. IP Routing is used to connect your network to another router through the Serial async port. Remote Access allows remote users to dial-in to the device to access and share network resources as if they were logged on to the network locally.

1. To configure the RF802EW for IP Routing, select **IP Routing** in the Async Port section of the **General Settings** dialog box.
2. Click **PPP Settings**.
3. The **IP Routing Settings** dialog box displays.

**IP Routing Settings**

You have selected the following ports as IP Routing ports

**Async**

IP Routing (NAT Enabled)

TelNumber

User Name

Password

Password Verification

External(Port)IP

Assign Remote Site an IP Address

Remote IP Address

Allow Remote Dial-In

Callback Settings

Remote Authentication Settings

OK Cancel Help

**IP Routing (NAT Enabled)** - If NAT is enabled, all local users will be firewall protected and will share one IP address through the Async port. Enter values in the fields as described:

**Tel Number** - Enter the phone number required to access your ISP.

**User Name** - Enter the account user name to be authenticated by your ISP.

**Password** - Enter the user account password to be authenticated by your ISP.

**Password Verification** - Re-enter the user account password for verification.

**External (Port) IP** - Enter the fixed IP address provided by the remote site System Administrator. If this address is automatically assigned by the remote site DHCP server, enter 0.0.0.0

**Assign Remote Site an IP Address** - Check the box if you will specify the IP Address of the remote site.

**Remote IP Address** - Enter the IP address the remote site will use.

**Allow Remote Dial-In** - This option allows a remote site to dial-in to this network.

1. From the **IP Routing Settings** dialog box, select **Allow Remote Dial-In**.
2. Click **Remote Authentication Settings**.
3. The **Remote Connection Authentication** dialog box displays.

4. Select one of three methods to define the authentication protocol to be used when a remote site is dialing in to your site:
  - **None** - No authentication needed.
  - **PAP** - User Name and unencrypted Password are transmitted over the network.
  - **CHAP** - DHCP sends a key which is used to encrypt the user name and password. Encryption provides added protection from potential interception of authentication information.

**Note:** If you select **PAP** or **CHAP**, you must indicate where the authentication process should occur, by selecting **Use Local Settings**, **Use Local Client List**, or **Use RADIUS Authentication**. Refer to Remote Connection Authentication Settings following this section.
5. Click **OK** when complete.

**Callback Settings** - From a remote site, you can trigger your RF802EW to establish a connection with your ISP.

1. Click **Callback Settings** and select one of three call back options:
  - **No Callback**
  - **Trigger (ISP) Server Connection** - The RouteFinder will establish a connection with the ISP server after a remote user dials into the asynchronous port. The device can be triggered to automatically establish a connection with the ISP in one of two ways:
    1. The ISP server is dialed after the RF802EW receives a PPP (modem) connection from a remote user.
    2. The RF802EW makes the connection to the ISP server after receiving a regular telephone call. The remote user calls the RF802EW async port to trigger the connection to the ISP server.
  - **Remote Callback** - After dialing, the RF802EW hangs up and waits for the remote site to callback. You must enter the callback telephone number (the telephone number the device should call) in the **Tel Number** box.
2. Click **OK** to complete.

**Remote Authentication Settings** - When you select Allow Remote Dial-in, you must determine the method that remote users must use to be authenticated on your system. If you choose the PAP or CHAP authentication protocol, you must select Use Local Settings, Use Local Client List or Use RADIUS Server authentication.

**Use Local Setting** - You may create a Remote User Name and Remote Password to log in to the system. All users must type the same user name and password that you specify.

**Use Local Client List** - The Local Client list is a list of all User Names and Passwords that can access your network from a remote site. When a remote user dials in to the RF802EW, the user's access profile information (user name, password, callback status, etc.) is validated by checking the user information in this list. The RF802EW can include up to 64 users in the Local Client list. Click Local Client List to add your remote users.

**Important:** The RF802EW is set up with a default user of guest which requires no password. For security reasons, either delete the user ID guest or provide it with a password.

**Client Information** - For each new remote user added to the system, enter the following information:

**User Name** - Specify a user name with a maximum of 16 characters.

**Password** - Specify the password corresponding to the user name. Passwords are limited to 16 characters.

**Password Verification** - Verify the password by re-entering the user password in the box provided.

**Callback Type** - The callback feature provides an added level of security to your dial in system. A remote client dials in to the network and then disconnects. The RF802EW then calls the client back. The feature can be implemented using **no callback**, **fixed callback**, or **variable callback**.

**No Callback** - The RouteFinder does not perform a callback function. This is the default setting.



**Fixed Callback** - The RouteFinder will connect to the client by dialing the number specified in the **Your TelNumber** box.

**Variable Callback** - This option allows the remote client to specify the phone number the RouteFinder should callback each time a dial up connection is established.

**Assign a specific IP address for this user** - Select this option if you would like to have a specific IP address assigned to this user. Enter the IP address. This IP address will be used each time the client logs in and will override the Assign Remote Site an IP Address option as shown in the **IP Router Setting** dialog box. Click **Add** to add this client to the Local Client List.

**Use Radius Authentication** - Choosing RADIUS Authentication allows you to use the user information (such as user name, password, IP address) stored on a separate RADIUS server on the network.

**Note:** A RADIUS Server (Remote Authentication Dial-In Service) is an accounting and authentication system used by many large companies and Internet Service Providers (ISPs). After a client dials into the network and enters their user name and password, the information is passed to a RADIUS server. The RADIUS server checks that the information is correct, and then allows access to the system.

1. From the Remote Access Settings dialog box, click **Use RADIUS Authentication**, then click **RADIUS Setup**.
2. The **RADIUS Configuration** dialog box displays.

The screenshot shows the 'RADIUS Configuration' dialog box. It features a title bar and a main area with the following elements:

- RADIUS Server Setting**: A dropdown menu currently showing 'Main RADIUS Server'.
- RADIUS Access Server IP Address**: A checkbox that is checked, followed by four input boxes containing the IP address 192.168.2.22.
- RADIUS Accounting Server IP Address**: A checkbox that is checked, followed by four input boxes containing the IP address 192.168.2.22.
- Secret**: A text input field containing six asterisks (\*\*\*\*\*).
- Secret Confirmed**: A text input field containing six asterisks (\*\*\*\*\*).
- Buttons**: Three buttons are located on the right side: 'OK', 'Cancel', and 'Help'.

3. Use the List box to select the Main or Backup RADIUS Server from which the device will be authenticated.
4. Enter the RADIUS Access Server IP Address and the RADIUS Accounting Server IP Address

**Note:** In most cases, the RADIUS Accounting Server and the Access server are the same device. If this is true for your configuration, enter the same IP address in both boxes.

**Secret** - Enter your Shared Secret.

**Secret Confirmed** - Re-enter your Shared Secret.

5. Click **OK** when complete.

## Remote Access Settings

1. From the **General Settings** dialog box, click the **Remote Access** radio button and then click the **Remote Access Settings** button.
2. The **Remote Access Settings** dialog box displays.

**Remote Access Settings**

You have selected the following ports for Remote Access

IP Assigned Method for Remote Clients

Assign an IP Address Automatically       Assign an IP Address Manually

Port    192    168    2    2

Network Protocol

Protocols       TCP/IP       IPX/SPX

IPX/SPX Frame Type      Autodetect

Remote Client Authentication

User Authentication       None       PAP       CHAP

Use Local Client List      LAN Local Client List

Use RADIUS Authentication      RADIUS Setup

OK    Cancel    Help

Enter the following:

**IP Assigned Method for Remote Clients** - A remote client must have an IP address to connect to the network. IP addresses may be assigned automatically from a designated IP address pool using DHCP, or the IP address may be manually assigned.

**Assign an IP Address Automatically** - The DHCP feature will issue the remote site user an IP address automatically if the DHCP function is enabled. If DHCP is disabled, the device will automatically search for a DHCP server and request an IP address for the remote client.

**Assign an IP address manually** - Enter an IP address for the remote client.

**Network Protocols** - You must select the network protocols you would like to enable for the dial-in service. The default enables both TCP/IP and IPS/SPX. If you do not need both protocols, you may disable one of them. If you are connecting to a Netware Server, IPX/SPX must be enabled.

**IPX/SPX Frame Type** - The RF802EW can automatically detect what kind of IPX/SPX frame type you are using. You may manually select a frame type by using the list box.

- Remote Client Authentication** - Remote authentication settings allow you to specify how you would like to authenticate remote users. You may select **Use Local Client List** or **Use RADIUS Authentication** (refer to Remote Connection Authentication Settings in this chapter for more information). Choosing RADIUS configuration allows you to use the user information (such as user name, password, and IP address) stored on a separate RADIUS server on the network.
3. Click **OK** when complete.

## Enable IP Mapping - Virtual Server

IP Mapping is available only when NAT is enabled. If NAT is enabled for a particular port, that port is firewall protected. The Enable IP Mapping function allows you to open a "hole" in your firewall to allow access to your LAN via the Internet. For example, you can use the IP mapping function to access an FTP server on your LAN via the Internet. IP Mapping is most suitable to fixed or static IP addressing.

1. To enable IP Mapping, from the **General Settings** dialog box, select **Enable IP Mapping**, then click **IP Mapping (Virtual Server)**.
2. The **Virtual Server Mapping** dialog box displays.

**Virtual Server Mapping**

IP Mapping applies to NAT Enabled Ports only

Address and Port Mapping

Port No: WAN Ethernet Port

External IP: [ ][ ][ ][ ] External Port: [ ]

Internal IP: [ ][ ][ ][ ] Internal Port: [ ]

Insert Delete

| No. | Port | External IP   | External Port | Internal IP  | Internal Port |
|-----|------|---------------|---------------|--------------|---------------|
| (1) | 1    | 200.172.45.16 | 80            | 192.168.2.12 | 80            |
|     |      |               |               |              |               |
|     |      |               |               |              |               |
|     |      |               |               |              |               |
|     |      |               |               |              |               |
|     |      |               |               |              |               |
|     |      |               |               |              |               |
|     |      |               |               |              |               |
|     |      |               |               |              |               |
|     |      |               |               |              |               |

OK  
Cancel  
Help

For each service you want to set up:

1. Select either the WAN or Async (Serial) port from the **Port No** list.
2. Enter the External IP address supplied by your ISP. If your ISP uses dynamic IP addressing, enter 0.0.0.0. Your device will use the dynamically assigned address when connecting to your ISP.

- 
3. Enter the TCP/IP port number for the service that you will be using for IP mapping. Common TCP/IP port numbers are listed below:
    - WWW Port 80
    - FTP Port 20 or 21
    - SMTP Port 25
    - POP3 Port 110

If you would like to map all services for this external IP address to a computer on your LAN, you can enter port number 0. This means that whenever anyone accesses your external IP address, they will automatically be "mapped" to the internal computer that you specify, regardless of what port number they are using.

4. Enter the Internal IP address of the server to which you want to map the External IP address.
5. Enter the port number for the service that you will be using for this IP mapping. Click **Insert** to include the mapping.
6. Click **OK** when you have completed mapping addresses.

**Note:** IP Mapping function allows you to have only one port service on your LAN. For example, if you map an external IP (16.895.1.3) to an internal IP address (192.168.2.22 - a www server), only the internal IP address in your local network can serve as the www.server for the external IP address.

## Port Settings Option from the Manager Main Screen

The Modem Settings options are used to configure the communication between your modem or ISDN TA and your RouteFinder serial port. You must specify the baudrate, modem and modem string settings for your device.

1. To view or change the port settings, from the main **Manager** dialog box, click **Port Settings**. The **Port Settings** dialog box displays.

2. Complete the following:

**Baudrate** - Use the list to select the Remote Access DTE speed for your device.

The absolute maximum setting for a given port on the network device is 4 x the speed of your modem. If the baudrate is set too high, your network device may fail to establish a dial-up connection. For example, if you have a 14.4Kbps modem, the highest speed selected is 57.6Kbs.

If your modem does not appear in the list provided, the Standard Modem selection will work in most cases.

**Important:** If you are using an ISDN Terminal Adapter, refer to the Async to Sync PPP string in the User Manual provided with the device to determine the correct initialization, dialup, and hang up strings.

**Note:** Due to variations in ISP connections and phone line quality, this theoretical maximum speed is not attainable. You may need to set the baudrate at a lower speed.

## Edit Login Script for Remote Access

1. From the **Port Settings**, click **Edit Login Script**.
2. The **Login Script** dialog box displays.

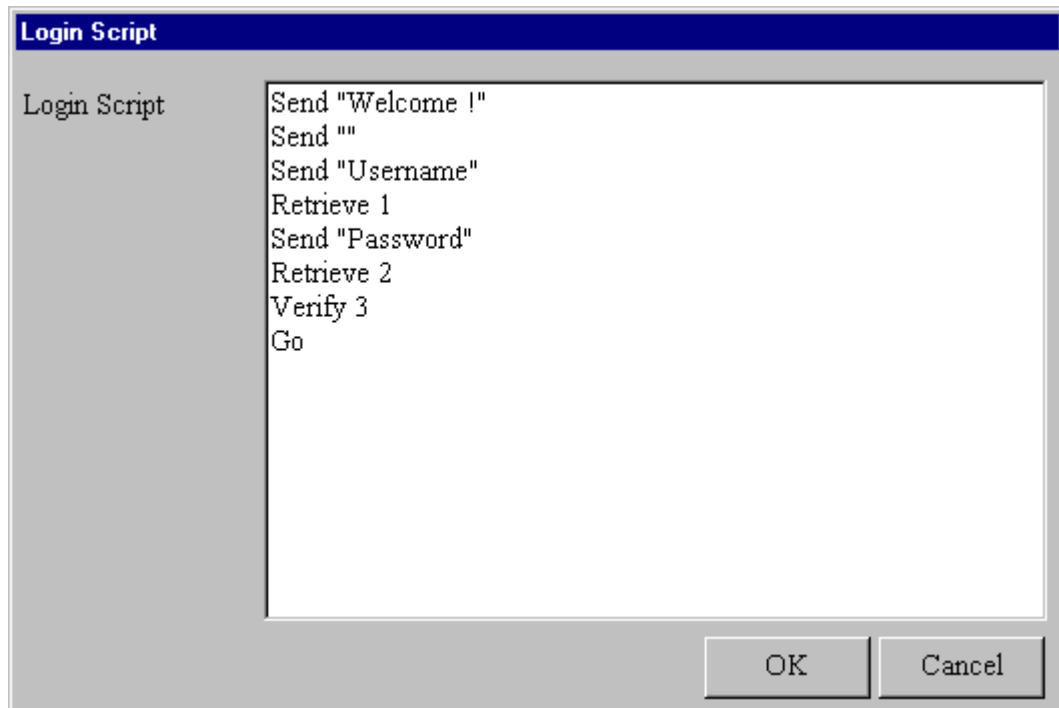

A sample remote access login script is shown below. If a remote access client is configured to **bring up a terminal window after dialing**, this remote access login script initiates.

For Remote Access, the device will act as the server side...

**Send "Welcome!"** displays **Welcome** to remote site.

**Send ""** sends an Enter (Carriage return + line feed) to the remote site.

**Send "Username"** prompts the remote site for a user name.

**Retrieve 1** will wait for the remote site to enter the user name that will be used for PPP authentication.

**Send "Password"** prompts the user for a password.

**Retrieve 2** will wait for the remote site to enter a password.

**Verify 3** instructs the device move to login script line 3 if PPP authentication fails.

**Go** means start PPP protocol.

## Writing a Login Script for IP Routing

To write an effective login script, you must obtain the correct login script information from your ISP and become familiar with using the login script commands.

Every ISP has a unique login interface screen. Check with your ISP to determine how your ISP requests information from you when using a PPP connection.

**Note:** You can create a simple dial-up connection to view your ISP interface log-in screen using Dial-Up Networking in Windows 95, 98, NT or 2000.

Some common commands are:

|                      |                                                                                                                                                           |
|----------------------|-----------------------------------------------------------------------------------------------------------------------------------------------------------|
| <b>Send and SH</b>   | <b>FUNCTION</b>                                                                                                                                           |
| Send "ATZ"           | Resets the Modem                                                                                                                                          |
| Send "ATDT 888-1234" | Dials the phone number "888-1234"                                                                                                                         |
| Send "JaneDoe"       | Types "JaneDoe" at the ISP interface                                                                                                                      |
| SH "1234"            | Types "1234" at the ISP interface but displays **** on the RouteFinder monitor to hide the password.                                                      |
| Send''               | Sends Enter (carriage return plus line feed) to the ISP                                                                                                   |
| <b>Wait</b>          | <b>FUNCTION</b>                                                                                                                                           |
| Wait 5               | The Modem will wait for 5 seconds before moving to the next line in the login script.                                                                     |
| Wait "CONNECT"       | The Modem will wait for CONNECT to display before moving to the next command.                                                                             |
| Wait "CONNECT 6"     | Modem will wait for "CONNECT" to display before moving to the next command. If CONNECT does not display, the modem will go to line 6 of the login script. |
| <b>Other</b>         | <b>FUNCTION</b>                                                                                                                                           |
| Go                   | Begins PPP                                                                                                                                                |
| Jump4                | Goes back to line 4 of the login script.                                                                                                                  |
| Hangup               | Hangs up the modem.                                                                                                                                       |

### Example 1: Script for Normal Reliable ISP

| #  | Login Script       | Meaning of Each Login Script Command     |
|----|--------------------|------------------------------------------|
| 1  | Send"ATZ"          | Rests Modem                              |
| 2  | Send"ATSO =1"      | Sends initial string "ATSO =1" to modem  |
| 3  | Send"ATDT888-1234" | Dial phone number 888-1234               |
| 4  | Wait"CONNECT"      | Waits for ISP to send reply "CONNECT"    |
| 5  | Wait"username:"    | Waits for ISP to send reply "username"   |
| 6  | Send"JaneDoe"      | Sends the user name "JaneDoe" to the ISP |
| 7  | Wait"password"     | Waits for ISP to send reply "password"   |
| 8  | SH"1234"           | Sends password "1234" to the ISP         |
| 9  | Wait"===>"         | Waits for ISP to send reply "===>"       |
| 10 | Send"1"            | Selects option 1 (PPP) for this ISP      |
| 11 | Go                 | Starts PPP mode                          |

### Example 2 : Script for Unreliable ISP (Redial until connected)

| # | Login Script      | Meaning of Each Login Script Command                                               |
|---|-------------------|------------------------------------------------------------------------------------|
| 1 | Send"ATZ"         | Resets Modem                                                                       |
| 2 | Send"ATSO =1"     | Sends initial string "ATSO =1" to modem                                            |
| 3 | Send"ATDT8881234" | Dials phone number 888-1234                                                        |
| 4 | Wait"CONNECT"2    | Wait for ISP to send reply "CONNECT". If no CONNECT, returns to line 2 to re-dial. |
| 5 | Wait"username:"12 | Waits for ISP to send reply "username". If no response, goes to line 12.           |

|    |                |                                         |
|----|----------------|-----------------------------------------|
| 6  | Send"JaneDoe"  | Sends the username "JaneDoe" to the ISP |
| 7  | Wait"password" | Waits for ISP to send reply "password"  |
| 8  | SH"1234"       | Sends password `1234` to ISP            |
| 9  | Wait"====>"    | Waits for ISP to send reply "====>"     |
| 10 | Send"1"        | Selects option 1 (PPP) for this ISP     |
| 11 | Go             | Starts PPP mode                         |
| 12 | Hangup         | Hangs up Modem                          |

### Example 3 : Script for Unreliable ISP (2nd ISP backup)

| #  | Login Script        | Meaning of Each Login Script Command                                                |
|----|---------------------|-------------------------------------------------------------------------------------|
| 1  | Send"ATZ"           | Resets modem                                                                        |
| 2  | Send"ATS0 =1"       | Sends initial string "ATS0 =1" to modem                                             |
| 3  | Send"ATDT8881234"   | Dials phone number 888-1234                                                         |
| 4  | Wait"CONNECT" 12    | Waits for ISP to send reply "CONNECT". If no reply, goes to line 12 for ISP #2.     |
| 5  | Wait "username:" 12 | Waits for ISP to send reply "username". If no response, goes to line 12 for ISP #2. |
| 6  | Send"JaneDoe"       | Sends the username "JaneDoe" to ISP                                                 |
| 7  | Wait"password"      | Waits for ISP to send reply "password"                                              |
| 8  | SH"1234"            | Sends password "1234" to ISP                                                        |
| 9  | Wait"====>"         | Waits for ISP to send reply "====>"                                                 |
| 10 | Send"1"             | Selects option 1 (PPP) for this ISP                                                 |
| 11 | Go                  | Starts PPP mode (Rest of script ignored)                                            |
| 12 | Hangup              | Hangs up Modem                                                                      |
| 13 | Send "AT S0=1"      | Sends initial string "AT S0=1" to modem                                             |
| 14 | Send "ATDT 8885678" | Dials phone number 888-5678 (ISP #2)                                                |
| 15 | Wait "Connect" 23   | Waits for ISP to send reply "CONNECT". If no CONNECT, goes to line 23.              |
| 16 | Wait "username:" 23 | Waits for ISP to send reply "username". If no response, goes to line 23.            |
| 17 | Send "Stephen"      | Sends the username "Stephen" to ISP                                                 |
| 18 | Wait "password:"    | Waits for the ISP to send "password:"                                               |
| 19 | SH "5678"           | Sends password "5678" to ISP                                                        |
| 20 | Wait"====>"         | Waits for ISP to send reply "====>"                                                 |
| 21 | Send"1"             | Selects option 1 (PPP) for this ISP                                                 |
| 22 | Go                  | Starts PPP mode                                                                     |
| 23 | Hangup              | Hangs up Modem                                                                      |
| 24 | Jump 2              | Goes back to line 2 to re-dial ISP #1                                               |

**Modem String Settings** - The most important modem string is the initialization string because your network device uses it to establish communications with your modem or ISDN TA. The modem initialization string displayed is the modem or ISDN TA initialization string entered in the Setup Wizard. For most analog modems, the Standard Modem selection will work. For additional information, refer to the Modem Settings information presented in the Software Installation and Configuration Chapter of this User Guide.

**Important:** There is no standard ISDN TA initialization string. If your ISDN TA is not included in the modem list, check your ISDN TA User's Guide for information for the initialization string for an Asynchronous to Synchronous PPP connection. If you are using only one channel of your ISDN connection, you can enter the Async to Sync PPP initialization string. If you are bundling your connection channels, use a Multilink-PPP initialization string. You must also enter the two phone numbers in the **Telephone Number** box of the **General Settings** dialog box. Also verify that your ISDN TA supports the dial-up string ATDT. Most ISDN TAs support ATDT, but some support ATD or ATDI.



**Dial-up/Hang-up Settings** - The Dial-up/Hang-up settings allow you to specify your connection time (idle timeout or auto reconnect) and the number of times to attempt to connect if a connection cannot be established.

1. From the main **Manager** dialog box, click **Port Settings**.
2. Click **Dial-up/Hang-up Settings**. The **Dial-up/Hang-up Settings** dialog box displays.

**Dialup / Hangup Settings**

Async Port    Remote Access

**Individual Port Options**

|            |                                                  |             |                                                                            |
|------------|--------------------------------------------------|-------------|----------------------------------------------------------------------------|
| WAN Port   | <input type="checkbox"/> Idle Timeout            | 0 minute(s) | <input checked="" type="checkbox"/> Automatic Reconnect (Always Reconnect) |
| Async Port | <input checked="" type="checkbox"/> Idle Timeout | 0 minute(s) | <input type="checkbox"/> Automatic Reconnect (Always Reconnect)            |
| Port 3     | <input type="checkbox"/> Idle Timeout            | minute(s)   | <input type="checkbox"/> Automatic Reconnect (Always Reconnect)            |
| Port 4     | <input type="checkbox"/> Idle Timeout            | minute(s)   | <input type="checkbox"/> Automatic Reconnect (Always Reconnect)            |
| Port 5     | <input type="checkbox"/> Idle Timeout            | minute(s)   | <input type="checkbox"/> Automatic Reconnect (Always Reconnect)            |
| Port 6     | <input type="checkbox"/> Idle Timeout            | minute(s)   | <input type="checkbox"/> Automatic Reconnect (Always Reconnect)            |
| Port 7     | <input type="checkbox"/> Idle Timeout            | minute(s)   | <input type="checkbox"/> Automatic Reconnect (Always Reconnect)            |
| Port 8     | <input type="checkbox"/> Idle Timeout            | minute(s)   | <input type="checkbox"/> Automatic Reconnect (Always Reconnect)            |

**Dialup Retry Options**

|                      |   |                        |   |
|----------------------|---|------------------------|---|
| WAN Port Retry count | 3 | Async Port Retry Count | 3 |
| Port 3 Retry count   |   | Port 4 Retry count     |   |
| Port 5 Retry count   |   | Port 6 Retry count     |   |
| Port 7 Retry count   |   | Port 8 Retry count     |   |

\*Note. If retry count 0 then the port will not be triggered to dial

OK    Cancel    Help

**Individual Port Options** - Individual Port Options lets you set the idle-timeout function for each serial port of the RouteFinder. You can set the number of minutes you wish to allow a connection to stay idle before disconnection.

**Note:** Default idle timeout for IP Routing is 5 minutes. Default idle timeout for Remote Access is 30 minutes.

If you un-check the idle-timeout, once a client establishes a connection, the connection will be maintained until you turn off your modem, unplug your network device or use the **Terminate Connection** function in the RouteFinder monitor program.

The Automatic Reconnect (Always connect) essentially maintains your connection (idle time out = infinite). If the connection is disconnected for any reason, it will automatically attempt to reconnect.

**Dial-up Retry Options** - The Dial-Up Retry option allows you to specify the number of times the RouteFinder should attempt to establish a connection.

If the retry count is 0, the device will not dial-out to connect to the remote site.

**Note:** Automatic Reconnect overrides the Retry count setting if retry count is set to 0.

## LAN DHCP Server Option from the Manager Main Screen

**Note:** Refer to the Glossary at the back of this User Guide for more information about the DHCP function.

1. From the main **Manager** dialog box, click **LAN DHCP Server**.

**Note:** The LAN DHCP Server option indicates if DHCP is Enabled or Disabled. By default the DHCP function is Enabled. To Disable the function, you must open the DHCP Configuration dialog box, select **Disabled** and click **OK**.

2. The **DHCP Configuration** dialog box displays.

3. Complete the following information:

**DNS IP Address** - Enter the ISP's DNS IP address. You may enter up to four ISP DNS IP addresses. Click **Insert**.

**IP Address Pool** - The IP Address Pool contains the range of IP addresses that will be automatically assigned to the clients of your network as they connect to the network.

**Note:** By default, the IP address pool range is from 100 to 200. Ranges are listed in the IP Address Pool table.

To change the range:

1. Select the existing range of addresses.
2. Enter a new range.
3. Press **Insert**.

To delete an IP Address range:

1. Select the range of addresses.
2. Press **Delete**.

**IP Address Mapping Reservation** - You can use the IP Address Mapping Reservation option to give a static IP address to particular computers on your network. Each time a computer is powered on and connects to the network, it will receive the same IP address. Static IP addresses are frequently assigned to network resources such as printers, servers, hubs, and routers that are consistently shared by network clients.

To assign a static IP Address:

Enter the MAC address manually or use the MAC address search tool.

To use the MAC address search tool:

1. Enter the IP address of the computer.
2. Click **Search** to find the MAC address.
3. Once the address has been located, click **Add** to reserve the address.

To delete a static IP Address:

1. Select the static address you would like to delete.
2. Click **Delete**.

**Note:** Refer to the User Guide Glossary for information about determining a computer's netmask address.

## Routing Settings Option from the Manager Main Screen

Routing is the process of moving a packet of data from source to destination. The RF802EW acts as a router to enable messages to pass from one computer to another and eventually reach the target machine. Part of this process involves analyzing a routing table to determine the best path. Use the information below to create a routing table to connect your network to another network, or to connect subnets within your network.

**Note:** A routing table is required to use the LAN-to-LAN routing function of the RF802EW.

1. From the main **Manager** dialog box, select **Routing Settings**.
2. The **Routing Settings** dialog box displays.

**Static Routing**

Static Routing Table

IP: [ ][ ][ ][ ][ ]

Netmask: [ ][ ][ ][ ][ ]

Gateway: [ ][ ][ ][ ][ ]

Interface: Ethernet (Local Network) ▾

Insert

Default Gateway

Gateway: [ ][ ][ ][ ][ ]

Interface: Ethernet (Local Network) ▾

Add Default Gateway

| No. | IP Address | Netmask | Gateway | Interface | Delete |
|-----|------------|---------|---------|-----------|--------|
|     |            |         |         |           |        |
|     |            |         |         |           |        |
|     |            |         |         |           |        |

**Dynamic Routing**

RIP Settings

OK

Cancel

Help

**Static Routing** - For each different subnet on your LAN, enter:

**IP** - Enter the (network/subnet) IP address to which you want to route.

**Netmask** - Enter the subnet mask of your Network IP address.

**Gateway** - Enter the IP address of the gateway device linking your network to the other network/subnet. The IP address should be in the same subnet as your RF802EW. If you are using this device with the LAN -to- LAN function, the gateway IP should be set as the IP address of the RouteFinder.

**Interface** - Select the port (LAN or WAN) that the routed packet should pass through. Select **Local Network** if you are using a separate router. If you are using the RF802EW with the LAN-to-LAN function, the Interface should be set as the WAN port that connects you to the other subnet.

Click **Insert** to save the information to the routing table.

To delete this information, select it from the routing table and click **Delete**.

**Default Gateway** - Default gateway is an IP address that all packets are routed to, when the device is unable to find a route match (the destination IP address of the packet in the routing table).

Click **Add Default Gateway** to save the IP address of the default gateway.

**Interface** - Select the port (LAN or WAN) interface where the gateway is located.

## Routing Table Example

The routing table stores the routing information so that the RF802EW knows how to route the IP packets to the proper network.

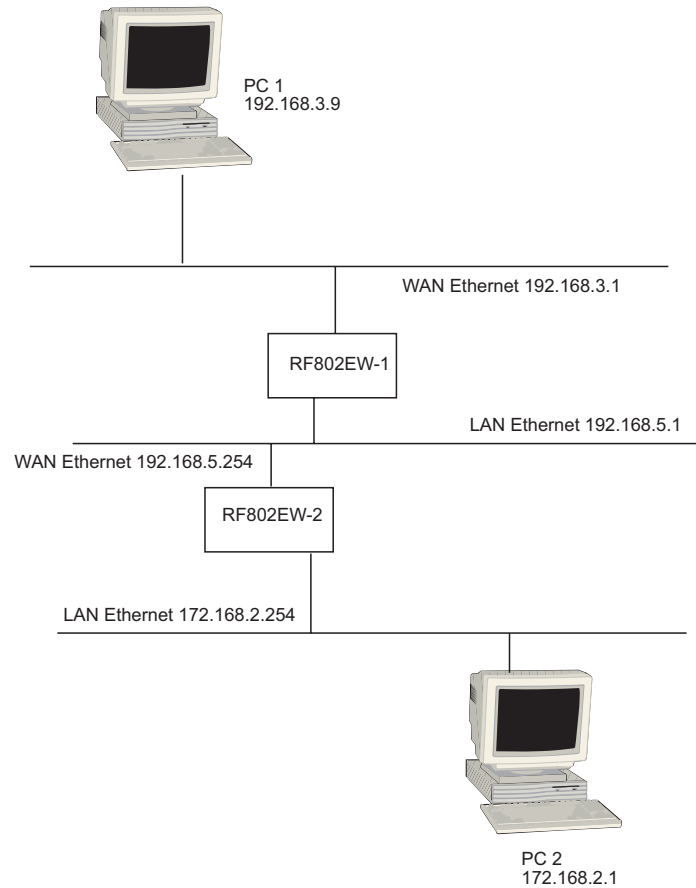

### What is the purpose of the routing table?

In the diagram above, the RF802EW-1 has the routing information to route between 192.168.3.x and 192.168.5.x. The device does not have the information about how to route to the 172.168.2.x network. If you want the RF802EW-1 to route to 172.168.2.x, you must add the following information to the routing table:

IP: 172.168.2.0  
 Network: 255.255.255.0  
 Gateway IP: 192.168.5.254  
 Interface: Ethernet (Local Network)

If you would like the RF802EW-2. to route to 192.168.3.x, enter the following routing table information into the RF802EW Routing settings:

IP: 192.168.3.0  
 Network: 255.255.255.0  
 Gateway IP: 192.168.5.1  
 Interface: WAN Ethernet

## Filter Settings Option from the Manager Main Screen

You can use Filter Settings to choose which packets are allowed to enter the network and which packets will be blocked. Filter Settings can be used to filter network services such as Mail, WWW, FTP, Telnet and News.

1. From the main **Manager** dialog box, select your RF802EW, then **Filter Settings**.
2. The **Filter Settings** dialog box displays.

**Filter Settings**

**Block** | Pass

Enable Block IP Filter Function

Packet(s) Defined by: TCP/IP

Packet(s) Define by TCP/IP

IP Address: [ ][ ][ ][ ]

Netmask: [ ][ ][ ][ ]

TCP/IP Service Port: [ ][ ]

Privilege Level: 1 (highest level)

Insert

| No. | IP Address | Netmask | Service Port | Type |
|-----|------------|---------|--------------|------|
|     |            |         |              |      |
|     |            |         |              |      |
|     |            |         |              |      |
|     |            |         |              |      |
|     |            |         |              |      |
|     |            |         |              |      |
|     |            |         |              |      |
|     |            |         |              |      |

Delete

Enable Client Filter Settings

Client Filter Settings

OK Cancel Help

3. Select the **Block** tab or the **Pass** tab to define your filtering.
  - The Block function filters by blocking packets from going out the WAN port and coming in through the LAN port. To enable the Block IP filter function, select **Enable Block IP Filter Function**.
  - The Pass function filters by defining which packets can go into your WAN port and come on to your LAN. To enable the Pass IP filter function, click the **Pass** tab and select **Enable Pass IP Filter Function**.

4. To filter packets to be passed or blocked, use the **Packets Defined** by list to select **TCP/IP** or **User**.

**Packets Defined by TCP/IP** - If you choose to define by TCP/IP, you must enter the packet IP information.

**IP Address** - Enter the IP address of the packet to be Blocked or allowed to Pass.

**Netmask** - Enter the subnet mask for the packet.

**TCP/IP Service Port** - Enter the Socket Port you would like to block or allow to pass (for example, HTTP= 80)

**Privilege Level** - Use the Privilege list box to select an appropriate level for this filter. It is common to set many filter rules for a particular client. At times, the rules you have set may conflict with one another. When a conflict occurs, the filter with the higher privilege level will override the other filters.

**Note:** Level one is the highest level; level sixteen is the lowest privilege level.

**Example:** Let's say you configure a filter rule for IP address 192.168.100.72 with a privilege level of 16 to **Pass** using socket number 80. At the same time, you set the same filter rule to block IP Address 192.168.100.72 with a privilege level of one. The RF802EW will implement the filter to block the IP address 192.168.100.72 because the privilege level is higher.

**Note:** If conflicting rules have the same privilege level, then the RF802EW will block the packet.

Click **Insert** to add each IP address to the list.

To remove a defined packet, select the packet you'd like to delete from the table and click **Delete**.

**Packets Defined by User** - If you choose to define by User, you must define the byte pattern of the packets. The RF802EW uses the defined byte patterns to block or pass packets from the WAN or from the LAN.

1. In the **Block** dialog box, select **Enable Block User Defined Pattern Function**.
2. In the **Packets defined by User** list, select **From LAN** or **From WAN**.

**Starting from which byte number** - Indicate the first byte in the packet the RF802EW should read to determine if the byte pattern (in Hex) is one that should be filtered. Exclude the PPP header. Start from byte 0 of the network protocol.

**Byte Pattern (in Hex)** - Enter the packet byte pattern that you would like the RF802EW to recognize as a packet to be filtered. (Block/Pass from the WAN to the LAN). The maximum pattern size is 12 bytes.

Click **Insert** to add each byte pattern to the table.

To delete a defined packet, select the packet in the table and click **Delete**.

## Enable Client Filter Settings

The Client Filter allows you to decide which services are allowed into your network and which clients are authorized to access them.

1. From the **Filter Settings** dialog box, select **Enable Client Filter Settings**.
2. Click **Client Filter Settings**.
3. The **Filter Settings** dialog box displays.

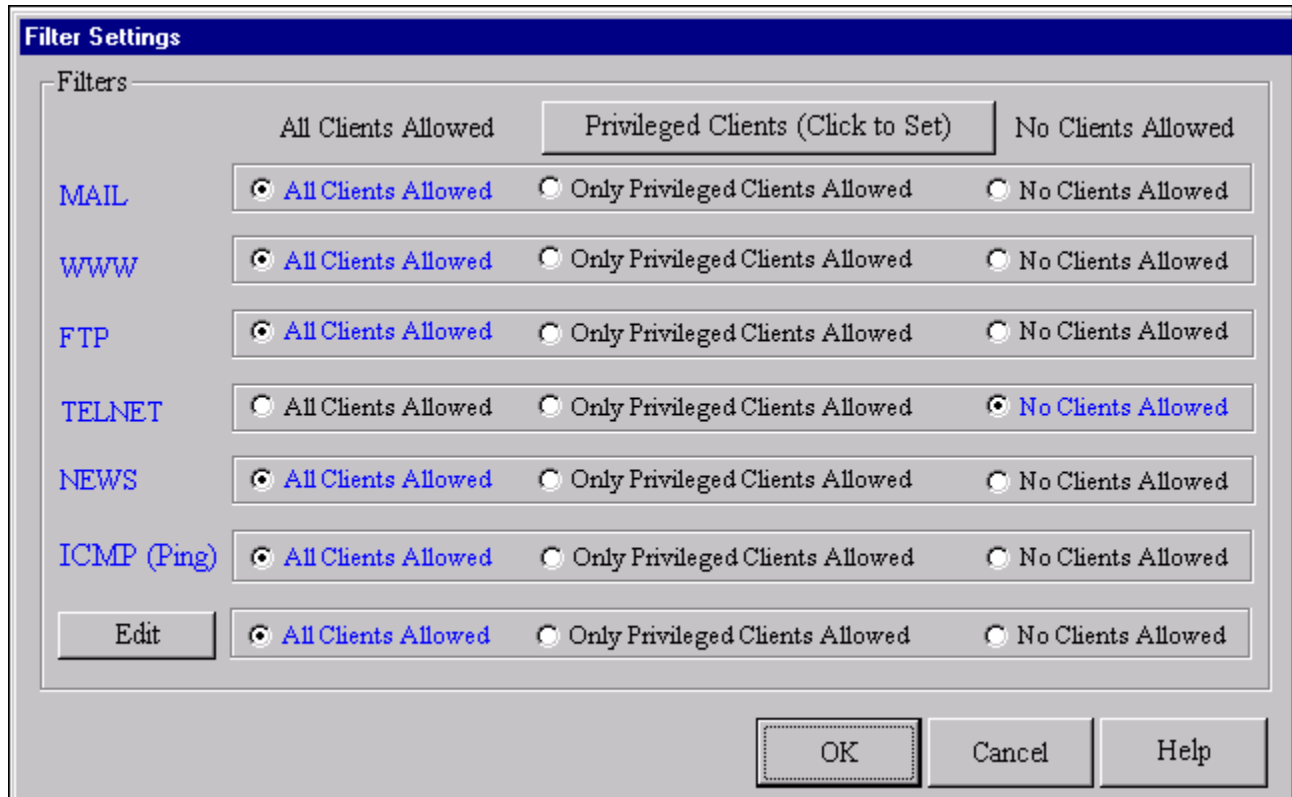

The filter works by filtering TCP/IP port numbers. The 5 most commonly used port numbers are listed for you. They include the port numbers for Mail, WWW, FTP, Telnet and News. If you would like to filter other services, you must know the port number for the service.

4. Click **Edit** to enter new service port numbers.
5. Enter the **TCP/UDP Port Number** and click **Add**.  
**Note:** Refer to the Glossary of the User Guide for a definition of Port.



6. Click **Privileged Clients**.
7. The **Privileged Client Table** dialog box displays.

**Privileged Client Table**

LAN Local Client List

Enter IP address to search for MAC address and add to list

IP Address

Node (MAC) Address

| No. | Node (MAC) Address |
|-----|--------------------|
|     |                    |
|     |                    |
|     |                    |
|     |                    |
|     |                    |
|     |                    |
|     |                    |
|     |                    |

Remote Clients (Applies only to Remote Access Port(s))

Include WAN Port 1 as Privileged Clients       Include WAN Port 2 as Privileged Clients

- LAN Local Client List** - In the Privileged Client Table, enter the clients you wish to have privileged access to the services that you have selected in the **Filter Settings** dialog box. The filter uses MAC addresses to identify the privileged clients. You can enter the MAC address directly or you can use the MAC address search tool by entering the IP address of the computer, then click **Search** to find the MAC address. After completing the IP Address and MAC (Node) address, click **Add** to include the information in the Node (MAC) address list.
- Remote Clients - Applies to Remote Access Port(s).** Select **Include WAN Async Clients as Privileged Clients** or **Include WAN Ethernet Clients as privileged clients** to filter Remote Clients by the port they are coming in through.
8. Click **OK** when complete.

## Wireless Settings Option from the Manager Main Screen

Click **Wireless Settings** in the **RouteFinder Manager** menu to open the **Wireless Settings** dialog box. You can enter the ESSID and Channel number for your wireless router. All wireless workstations must use the same ESSID. You may need to try different channels to avoid interference.

The image shows the 'Wireless Settings' dialog box. The 'ESSID' field contains 'Wireless'. The 'Channel' dropdown is set to '6'. The 'Encryption (WEP)' dropdown is set to 'Disabled'. Under the 'WEP Key Entry' section, the 'Create with Passphrase' radio button is selected. The 'Passphrase' field is empty, and the 'Generate Key' button is visible. The 'Manual Entry' radio button is unselected. Below it, there are four rows of key entry fields labeled 'Key1', 'Key2', 'Key3', and 'Key4', each containing five '0' characters. The 'Default Tx Key' dropdown is set to 'Key1'. At the bottom are 'OK', 'Cancel', and 'Help' buttons.

### Encryption (WEP)

The WEP is a data security measure. The RC4 algorithm encrypts the wireless portion of data transmissions. Select an encryption option from the list: **Disabled** (default), **40 bits (Must use shared with WEP)**, or **40 bits (WECA Compliant)**. When selecting either of the **40 bits** options, you can select the **Create with Passphrase** option, enter the words in the **Passphrase** box, then click **Generate Key**. Select a key from the **Default Tx Key** list. You can also select the **Manual Entry** option to enter the encryption keys manually.

The image shows the 'Wireless Settings' dialog box with 'Encryption (WEP)' set to '40 bits (Must use shared with WEP)'. Under the 'WEP Key Entry' section, the 'Create with Passphrase' radio button is selected. The 'Passphrase' field contains 'wireless AP', and the 'Generate Key' button is visible. The 'Manual Entry' radio button is unselected. Below it, there are four rows of key entry fields labeled 'Key1', 'Key2', 'Key3', and 'Key4', each containing five hexadecimal characters. The 'Default Tx Key' dropdown is set to 'Key1'. At the bottom are 'OK', 'Cancel', and 'Help' buttons.

|      |    |    |    |    |    |
|------|----|----|----|----|----|
| Key1 | 67 | 77 | C1 | 26 | 1F |
| Key2 | EE | 8F | 3E | D8 | E6 |
| Key3 | 56 | C4 | 73 | E6 | 7A |
| Key4 | A4 | 8C | F1 | B9 | 87 |

## MAC Access Control Option from the Manager Main Screen

You can use the **MAC Access Control** dialog box to disable, grant access, or deny access to the network.

**Disabled** - If you select this, MAC Access Control cannot be set.

**Grant or Deny Access Lists** - Choose to create your access control list based on whether work stations will or will not have access to the network. Choose the type of list that will create the lesser number of entries. For example, if a majority of the work stations will have access to the network, choose **Enable Deny Access List** to create the shorter list of those who will be denied access.

**Enable Grant Access List** - If you select this option, you can create a list MAC addresses that will have access to the network.

**Enable Deny Access List** - If you select this option, you can create a list MAC addresses that will not have access to the network.

**Client Access List** - Type the IP Address and the Node ((MAC) Address for the work station that will be granted or denied access to the network. Click the **Add** button. The address will display in the Node (MAC) Address box. An address can be deleted from this list by highlighting it and clicking the **Delete** button.

**Access Control**

Disabled
  Enable Grant Access List
  Enable Deny Access List

Grant Access List

Enter IP address to search for MAC address and add to list

IP Address: [ ][ ][ ][ ]

Node (MAC) Address: [ ][ ][ ][ ][ ][ ]

Search Add Delete

| No. | Node (MAC) Address |
|-----|--------------------|
|     |                    |
|     |                    |
|     |                    |
|     |                    |
|     |                    |
|     |                    |
|     |                    |
|     |                    |

OK Help

---

*RouteFinder*<sup>™</sup>

**Chapter 7**  
**RouteFinder Monitor**

## Chapter 7 - RouteFinder Monitor

RouteFinder Monitor is a utility that provides both monitoring and troubleshooting functions.

### Accessing the RouteFinder Monitor

1. Click on the RouteFinder Monitor icon, or select **Start | Programs | RouteFinder Manager | RouteFinder Monitor**.
2. The **RouteFinder Monitor** dialog box displays.

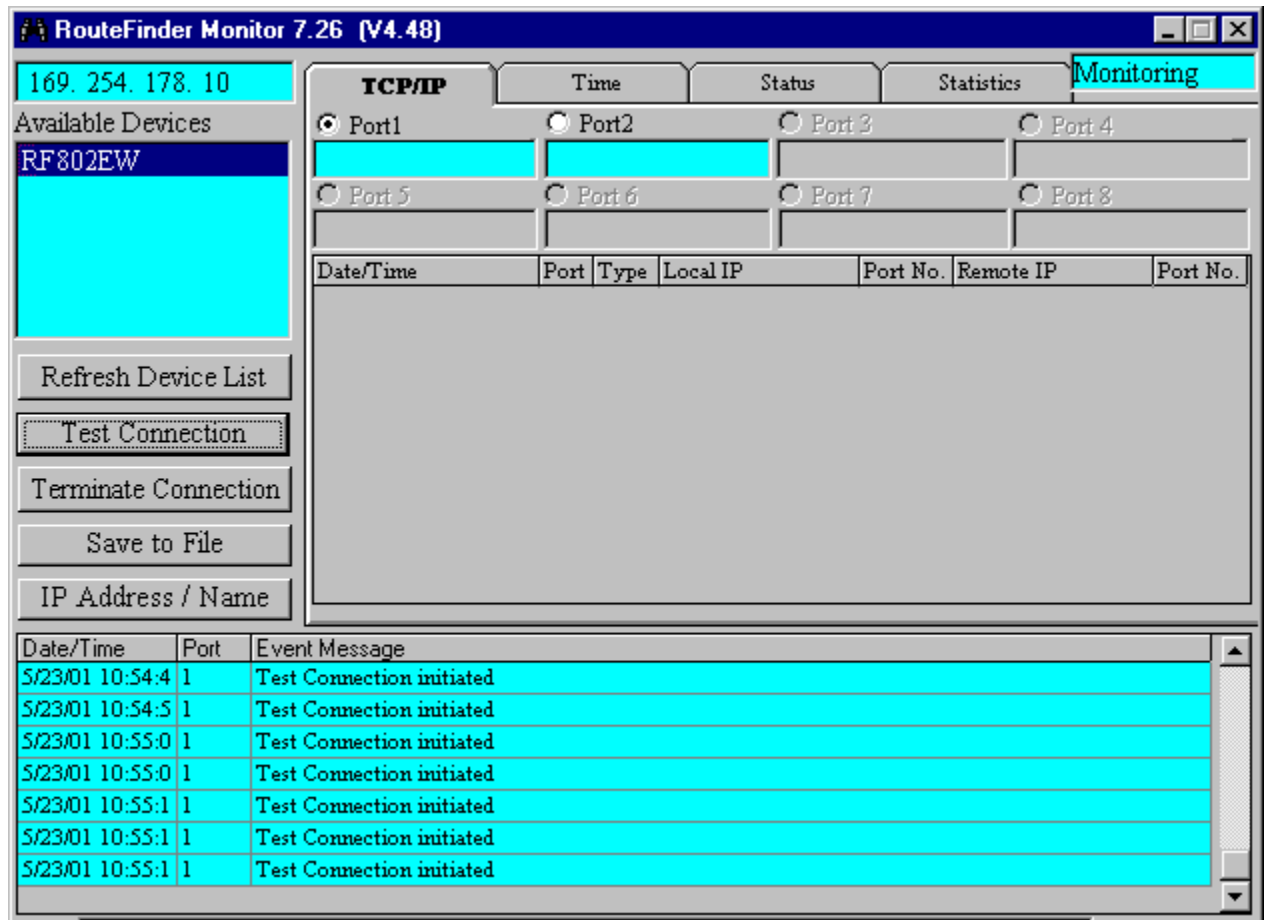

**Note:** If you receive a message stating "Device is not found", refer to the Troubleshooting chapter in this User Guide.

### Screen Options

#### Refresh Device List

Click **Refresh Device List** from the main **RouteFinder Monitor** dialog box to display a list of network devices in the **Available Devices** window.

## Test Connection

This option tests your connection settings and assist you in determining if problems are due to the modem, the RouteFinder, or an incorrect setting. Test Connection uses the attached modems to dial-up the remote server (ISP) and establish a connection.

1. From the main RouteMonitor dialog box, click **Test Connection** to begin testing.
2. The **Test Connection** dialog box displays.

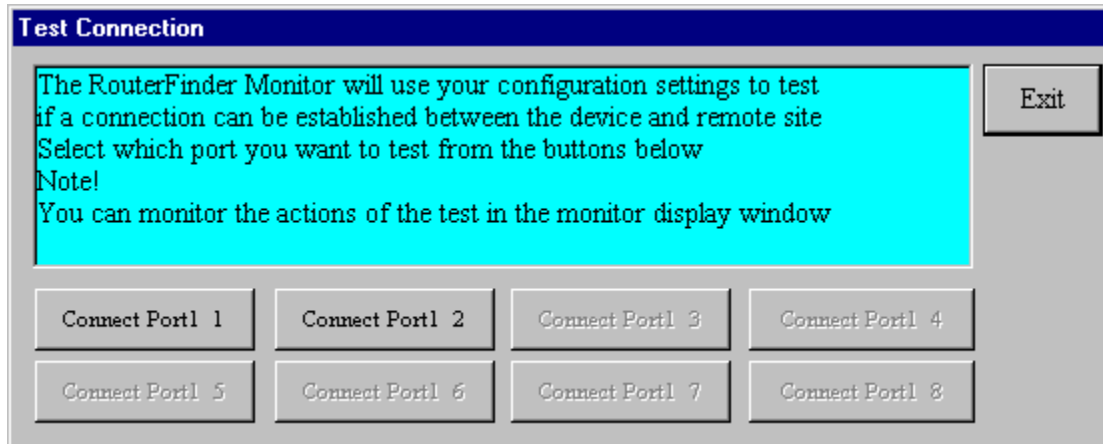

3. Select **Connect Port 1** to test the WAN connection, or **Connect Port 2** to test the Async connection.
4. The monitor display window displays the actions of the test.
5. To terminate the connection, refer to the **Terminate Connection** instructions which follow.
6. Click **Exit** to close the Test Connection dialog box.

## Terminate Connection

The **Terminate Connection** option is designed to allow the Network Administrator to terminate an RF802EW connection instantly.

1. From the main **RouteFinder Monitor** dialog box, select **Terminate Connection**.
2. The **Terminate Connection** dialog box displays.

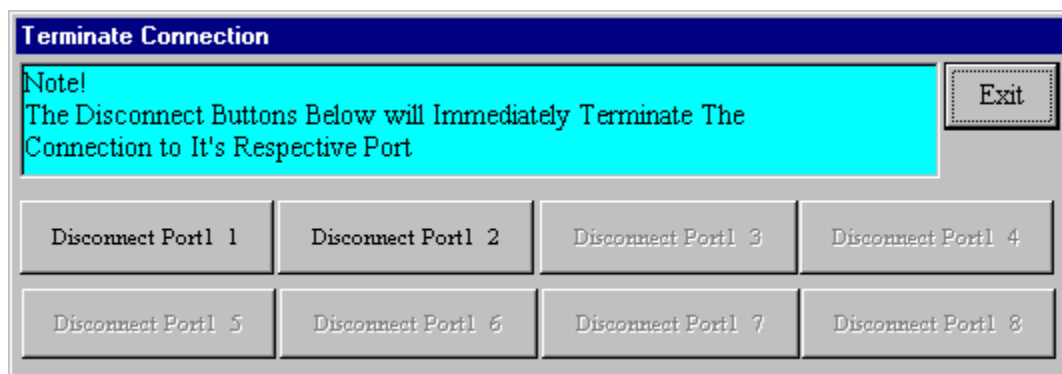

3. **Select Disconnect Port 1 or Disconnect Port 2.**
4. Click **Terminate Connection**.
5. Click **Exit** to return to the **RouteFinder Monitor** dialog box.

## Save to File

Click **Save to a File** to save a monitoring session to a file. This feature can be used to create an event log to send to our Technical Support group for evaluation.

1. From the main **RouteFinder Monitor** dialog box, select **Save to File**.
2. The **Save Log Files** dialog box displays.

**Save Now** - If you want to save the monitor display at any point in time, select the monitor you want to save to a file (TCP/IP, Event Message). Select the **File Name** and **File Directory** to which you'd like to save the file and click **Save**.

**Autosave** - If you wish to automatically save the information displayed on the monitor to a database file, enable the AutoSave function. Options for this function include:

**Overwrite database file** - This option saves the information collected by the monitor to a database file based on the time interval that you specify, overwriting the last saved database file.

**Append Database file** - This option saves the information collected by the monitor to a database file based on the time interval that you specify, updating and appending to the file.

**Note:** The Append Database file option will reset the monitor and clear the screens after the autosave has appended the information to the file.

**Warning:** The database size limit is equal to the amount of available disk space. Use this option with caution!

3. Click **OK** when complete.

## IP Address/Name

The IP Address/Name function allows you to associate a name with a particular IP address and name on your network. This information will appear in the relevant monitor displays. The IP Address/Name option is used to assist the Network Administrator in determining which users are transmitting and receiving data without having to remember their specific IP addresses.

Each computer listed must have a fixed IP address for your network. You may configure a fixed IP address on the individual computer or use the RF802EW's DHCP server IP reservation system. Refer to the LAN DHCP section of RouteFinder Manager chapter of this User Guide.

1. From the main **RouteFinder Monitor** dialog box, click **IP Address/Name**.
2. The **IP User Mapping** dialog box displays.

| No. | IP Address:  | Name        |
|-----|--------------|-------------|
| (1) | 192.168.2.22 | Ann Collins |
|     |              |             |
|     |              |             |
|     |              |             |
|     |              |             |
|     |              |             |
|     |              |             |

3. Enter each computer's IP Address and associated User Name in the provided fields.
4. Click **Add** after each IP address and name have been added to the list.
5. When all addresses have been added, click **OK**.

## Event Messages

**Event Messages** are displayed in the lower half of the **RouteFinder Monitor** display. Event Messages provide information about the communication occurring between your network device, ISDN TA/modem and the remote server (ISP).

To assist you in troubleshooting, you may point and click on any event message to bring up a help screen.



## TCP/IP Tab

The **TCP/IP** tab displays all TCP/IP requests made by your network device. You may select to view TCP/IP sessions for the WAN Ethernet or the Async Port.

1. The **TCP/IP** tab is the default tab displayed in the **RouteFinder Monitor** dialog box. If it is not displayed, click the **TCP/IP** tab.

| Date/Time            | Port | Type | Local IP        | Port No. | Remote IP       | Port No. |
|----------------------|------|------|-----------------|----------|-----------------|----------|
| 10/4/2000 9:08:33 AM | 1    | UDP  | 192.192.192.101 | 123      | 131.107.1.10    | 123      |
| 10/4/2000 9:08:33 AM | 1    | UDP  | 192.192.192.101 | 123      | 129.6.15.29     | 123      |
| 10/4/2000 9:08:33 AM | 1    | UDP  | 192.192.192.101 | 123      | 128.138.140.44  | 123      |
| 10/4/2000 9:08:33 AM | 1    | UDP  | 192.192.192.101 | 123      | 209.0.72.7      | 123      |
| 10/4/2000 9:08:33 AM | 1    | UDP  | 192.192.192.101 | 123      | 207.126.103.202 | 123      |
| 10/4/2000 9:08:33 AM | 1    | UDP  | 192.192.192.101 | 123      | 192.43.244.18   | 123      |

**Note:** The TCP/IP sessions displays the history of the TCP/IP session through the selected port. The TCP/IP information presented does not represent the current status of the TCP/IP session.

The **TCP/IP** tab displays the following information:

- Date/Time: Indicates the date the request was made.
- Port: Indicates the port you are viewing.
- Type: Displays the type of request being made.
- Local IP: Indicates which IP address you have requested information from.
- Remote IP: Indicates which IP address was requested.
- Port Number: Indicates which TCP/IP port was requested.

2. To exit RouteFinder Monitor, close the window.

## Time Tab

The Time Tab provides information about the amount of time the device has been powered on, the total connection time, the current connection time and the amount of data transferred and received.

1. From the main **RouteFinder Monitor** dialog box, click the **Time** tab.
2. The **Time** tab displays information for each port.

| Port | Power-On Time | Total Connection | Current Connection | Tx Bytes | Rx Bytes |
|------|---------------|------------------|--------------------|----------|----------|
| 1    | 17:54:20      | 00:00:00         | 00:00:00           | 18557    | 2493     |
| 2    | 17:54:20      | 00:00:00         | 00:00:00           | 0        | 0        |

**Device Power Turned On** - Displays the time and date that your RF802EW was powered on.

**Power-On-Time** - Displays the total time that has elapsed since your RouteFinder was started.

**Total Connection Time** - Displays the total connection time for each port that has been logged on since the RouteFinder was started.

**Current Connection** - Displays the time that has elapsed since the current connection was established for the port.

**TX Bytes** - Displays the total number of bytes transmitted for each port since your RouteFinder was last started.

**RX Bytes** - Displays the total number of bytes received for each port since your RouteFinder was last started.

3. To exit RouteFinder Monitor, close the window.

## Status Tab

The **Status** tab provides information about the status of the WAN Ethernet and Async ports.

1. From the **RouteFinder Monitor** dialog box, click the **Status** tab.
2. The **Status** tab information displays:

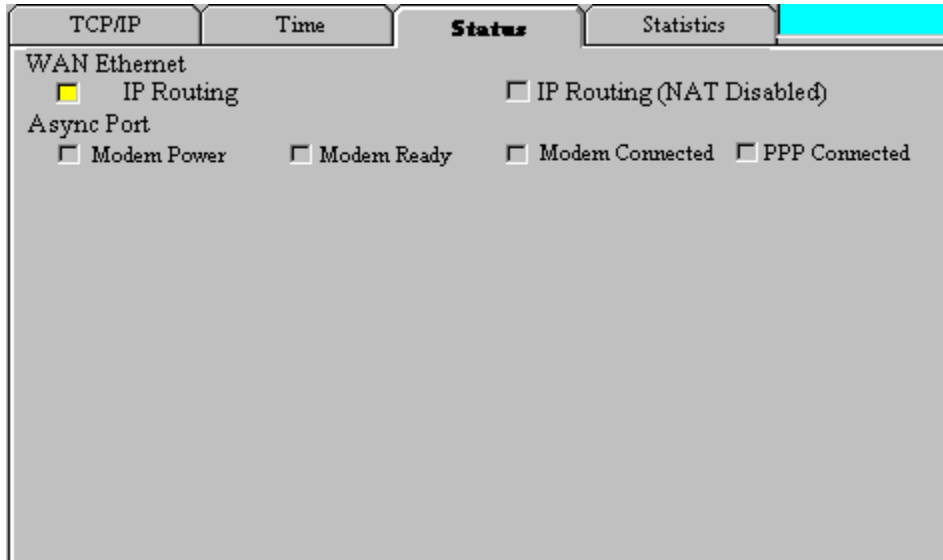

**WAN Ethernet** - This indicator light shows that either the **IP Routing** or the **Remote Access** function is in use.

### Async Port:

**Modem Power** - The indicator light is lit when the modem power is turned on.

**Modem Ready** - The Network Device sends a pre-initialization and initialization command to the modem or ISDN TA. If this communication is successful, the indicator light will be lit, indicating your modem is ready to make a connection.

**Modem Connected** - If the Network Device has detected that your modem has successfully dialed up a connection to a remote site, the indicator light will be lit.

**PPP Connected** - After a connection is established, if the RouteFinder has detected that the PPP connection is successful, this indicator light will be lit.

3. To exit RouteFinder Monitor, close the window.

## Statistics Tab

The Statistics tab indicates, by port, how many bytes of data have come in and out through the RouteFinder..

1. From the **RouteFinder Monitor** dialog box, click the **Statistics** tab.
2. The **Statistics** tab dialog box displays.

| IP Address:   | Tx Bytes | Rx Bytes | Total Bytes |
|---------------|----------|----------|-------------|
| 192.168.2.100 | 1945     | 0        | 1945        |
| 192.168.2.101 | 1368     | 0        | 1368        |

Reset

3. You may view the following information:

**IP Address** - The IP address of the network device.

**Name** - The Name as entered in the IP/Address name option of the Main RouteFinder Monitor dialog box.

**Tx Bytes** - Displays the number of bytes transmitted from the computer with this IP address.

**Rx Bytes**

Displays the number of bytes received from the computer with this IP address.

**Total Bytes**

Displays the total number of bytes received and transmitted from the computer with this IP address.

4. Click **Reset** to set the IP statistics to zero.
5. To exit RouteFinder Monitor, close the window.

---

*RouteFinder*<sup>™</sup>

**Chapter 8**  
**LAN Client Settings**

## Chapter 8 - LAN Client Settings

### Introduction

In order for a computer to access the Internet, the TCP/IP protocol must be installed on the computer. Computers on your local LAN as well as computers dialing in to your network may use dynamic or static IP addresses. Dynamic IP addresses may be automatically assigned by the DHCP function of the RF802EW or another DHCP server. Static IP addresses can either be reserved from the DHCP server or manually configured on the individual workstation.

To install or verify that TCP/IP is installed on your workstations, click **Start | Settings | Control Panel**, click **Network**, then view the **Protocol** information. If the TCP/IP protocol is not installed on your workstations, you must add it. Refer to the Adding TCP/IP section in the following pages, or your Windows documentation for assistance in adding the protocol.

The default setting in Windows is to have IP information (IP Address, DNS Server IP address and Gateway IP address) automatically assigned by a DHCP server such as the one built-in to your RouteFinder.

If you'd like to manually configure the IP addresses on your workstation, you will need to provide an IP address and subnet mask (the local LAN IP address and subnet you want to assign to the individual computer), a Gateway address (the local LAN IP address of your RouteFinder) and a DNS Server address (the DNS IP address provided by your ISP).

**Warning:** As a general rule, you should have only one DHCP server working on your network. If you decide to use a DHCP server other than that provided with your RouteFinder, you should use RouteFinder Manager to disable the DHCP LAN Server function. You should also set your RouteFinder's IP address as the gateway to the other DHCP server.

### Setting Up Remote Access Clients

Dial-in connections to Windows NT, Novell and Unix servers require slightly different configurations. This section discusses the settings necessary to connect a Windows 95/98/

**Note:** The Windows 2000 operating system has a Network Connection Wizard for making new connections. It is shown on the last page of the section.

The basic process consists of installing a dial-up adapter and a network protocol. Then, depending on the server to which you are connecting, you will likely need to install client software and specify the particular services you would like to use.

#### Accessing a Windows NT Server

Windows NT Server combines the best aspects of an application server, a file and printer server, a communications server, and a Web server, and its interoperability and management features make it an excellent network operating system (NOS) for organizations, whether they have mixed computing environments or operate entirely on Windows NT Server. Perform the following procedures when you need to connect your PC workstation to a remote Windows NT Server.

## Adding the Dial-Up Adapter (NT Server Connection):

### Windows 95/98:

1. Click **Start | Settings | Control Panel**.
2. Double-click the **Network** icon to open the **Network** dialog box.

Win95

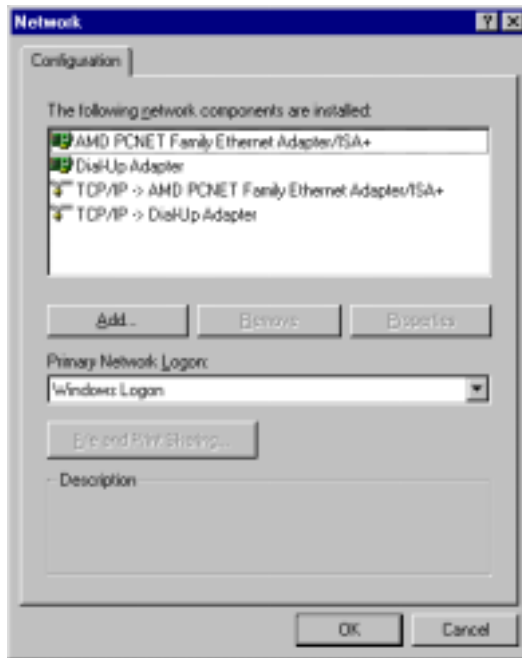

Win98

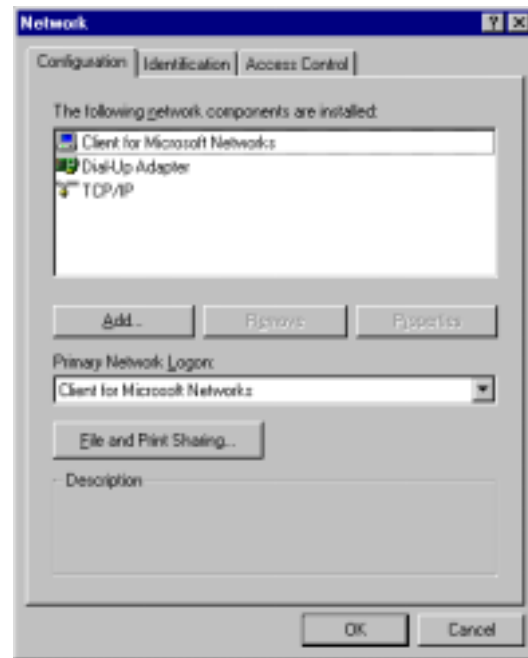

3. Click **Add**. The **Select Network Component Type** dialog box opens.

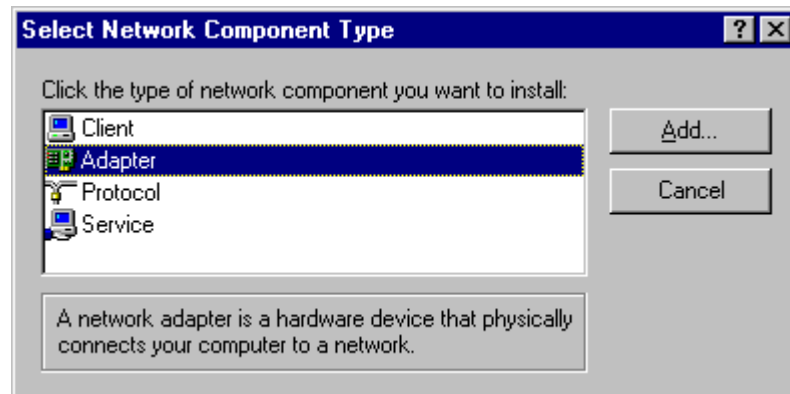

4. Select **Adapter**, then click **Add**. The **Select Network adapters** dialog box opens.

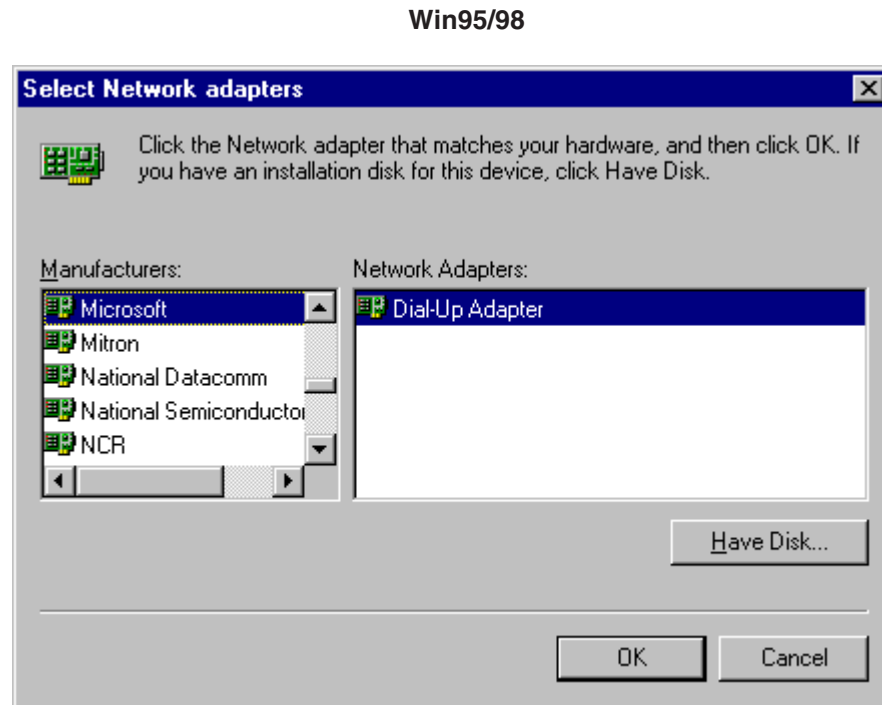

5. In the **Manufacturers** list, select **Microsoft**. In the **Network Adapters** list select **Dial-up adapter**.
6. Click **OK** (twice) to return to, and then close, the **Network** dialog box.

#### Windows NT:

Dial-up Networking adds PPP and SLIP protocol support, enabling your workstation to gain access to a remote computer or network, even if your computer is not on a network.

1. Double-click **My Computer**, then double-click **Dial-Up Networking**. The following screen is displayed:

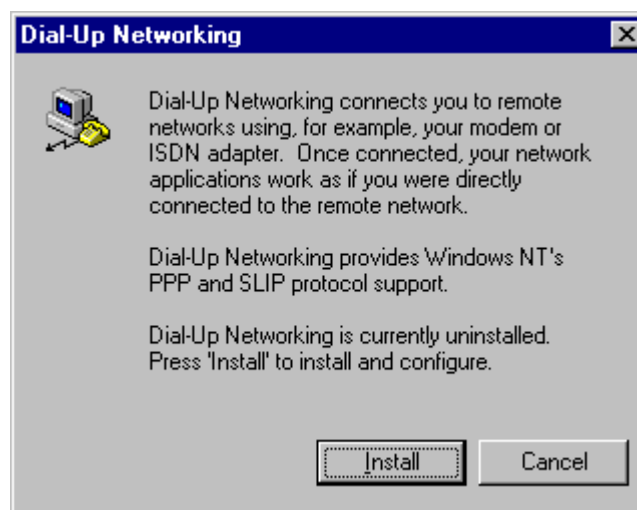

2. Click **Install**, then follow the on-screen instructions to configure your connection.



## Adding TCP/IP (NT Server Connection)

### Windows 95/98/NT:

1. In the **Network** dialog box, **Configuration** tab, click **Add**.
2. Select **Protocol** and click **Add**.
3. The **Select Network Protocol** dialog box is displayed. In the **Manufacturers** list [Win95 only], select **Microsoft**. In the **Network Protocols** list, select **TCP/IP** [Win95/98] or **TCP/IP Protocol** [WinNT only].

**Note:** Windows NT workstation has no **Manufacturers** list.

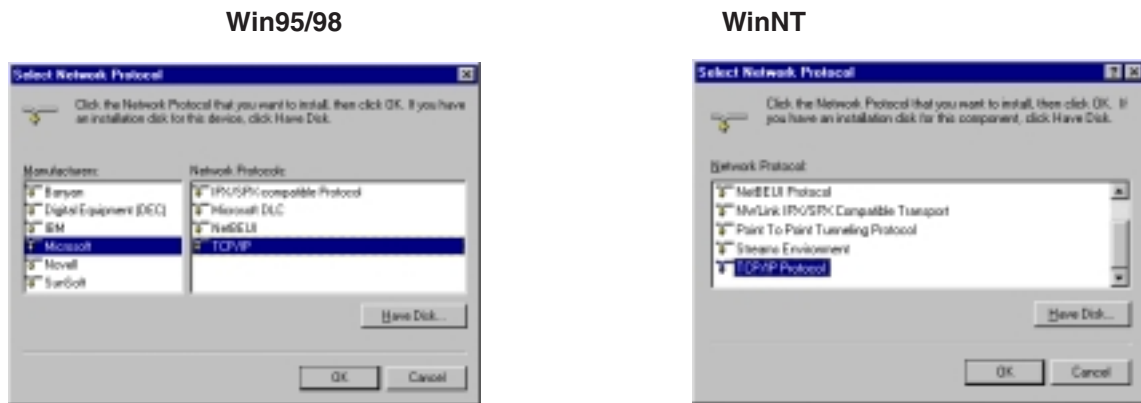

4. Click **OK** twice to return to, and then close, the **Network** dialog box.

## Adding Client for Microsoft Networks (NT Server Connection)

### Windows 95/98:

1. In the **Network** dialog box, **Configuration** tab, click **Add**.
2. Select **Network Client** and click **Add**.
3. The **Select Network Client** dialog box displays. In the **Manufacturer's** list, select **Microsoft**. In the **Network Clients** list, select **Client for Microsoft Networks**.

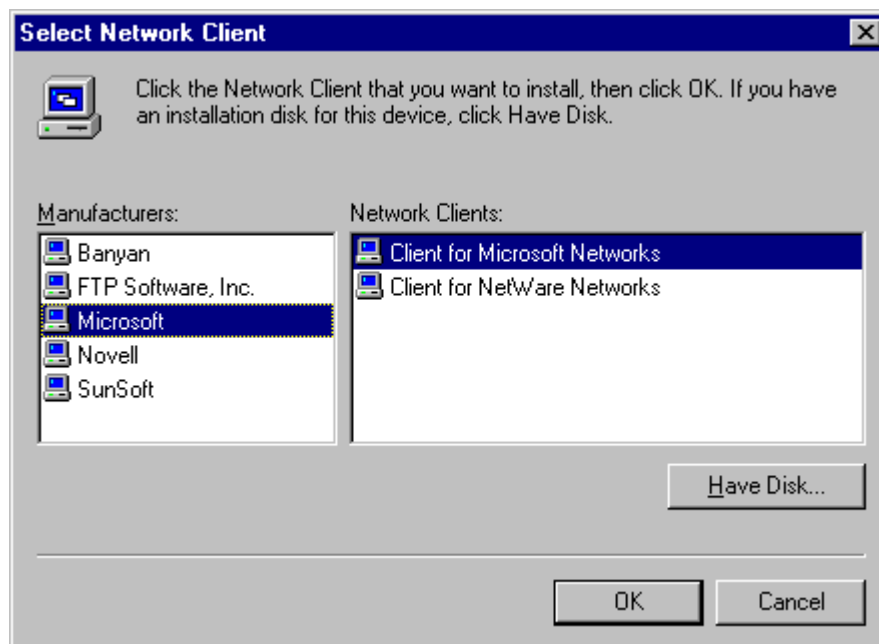

4. Click **OK** to add this Client and return to the **Network** dialog box.

## Adding File/Print Sharing for Microsoft Networks (NT Server Connection)

### Windows 95/98:

1. In the **Network** dialog box, **Configuration** tab, click **Add**.
2. Select **Services** and click **Add**.
3. The **Select Network Service** dialog box displays. In the **Manufacturers** list, select **Microsoft**. Select **File and Printer sharing for Microsoft Networks**.

**Note:** Windows 98 has no **Manufacturers** list.

**Win95**

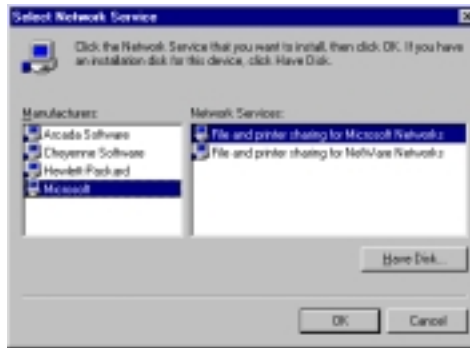

**Win98**

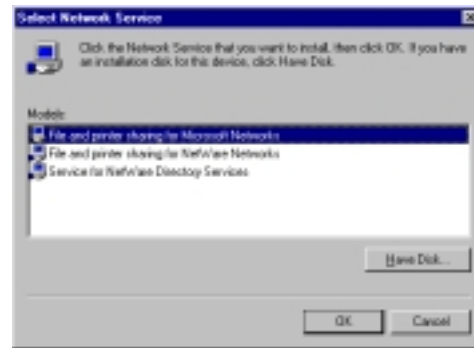

4. Click **OK** twice to return to, and then close, the **Network** dialog box.

## Set Your Primary Network Logon (NT Server Connection)

### Windows 95/98:

1. In the **Primary Network Logon** list on the **Configuration** tab of the **Network** dialog box, select (the previously installed) **Client for Microsoft Networks**.

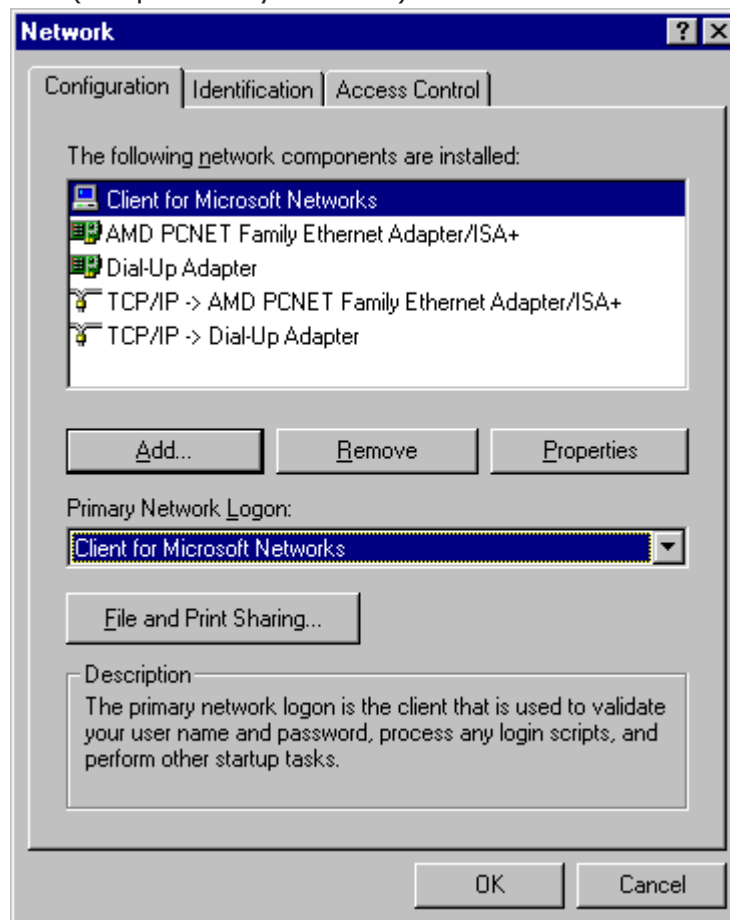

2. Click **OK** to close the **Network** dialog box.

## Set Up Properties of Components (NT Server Connection)

### Dial-up Adapter

#### Windows 95/98:

1. In the **Network** dialog box, **Configuration** tab, select the **TCP/IP - Dial-up adapter**.
2. Click **Properties**. The **TCP/IP Properties** dialog box opens with the **IP Address** tab selected.
3. Ensure that **Obtain an IP Address Automatically** is selected. (It's the default.)

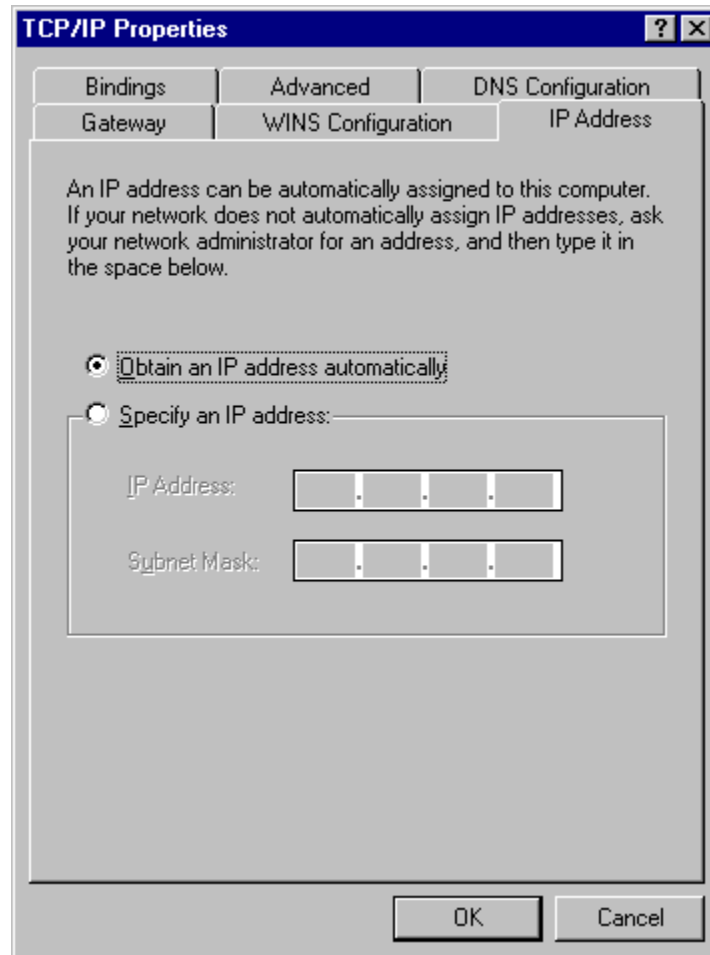

4. Click **OK** to close the **TCP/IP Properties** dialog box.

**Network Client****Windows 95/98:**

1. In the **Network** dialog box, **Configuration** tab, select **Client for Microsoft Networks**.
2. Click **Properties**. The **Client for Microsoft Networks Properties** dialog box opens.
3. On the **General** tab, select the **Log on to Windows NT domain** check box.
4. Enter the name of your Windows NT domain, as provided by your Network Administrator in the **Windows NT domain** box.

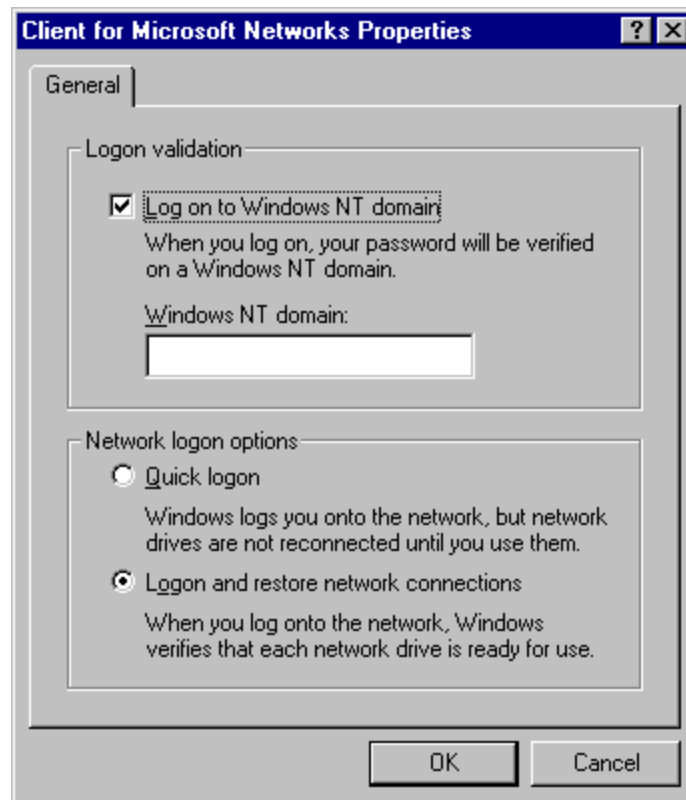

5. Click **OK** to return to the **Network** dialog box.

**Identification****Windows 95/98:**

1. In the **Network** dialog box, select the **Identification** tab.
2. In the **Workgroup** box, enter the name of your NT domain or the name of your workgroup as provided by your Network Administrator.
3. Enter a name and description for your computer.
4. Click **OK**.

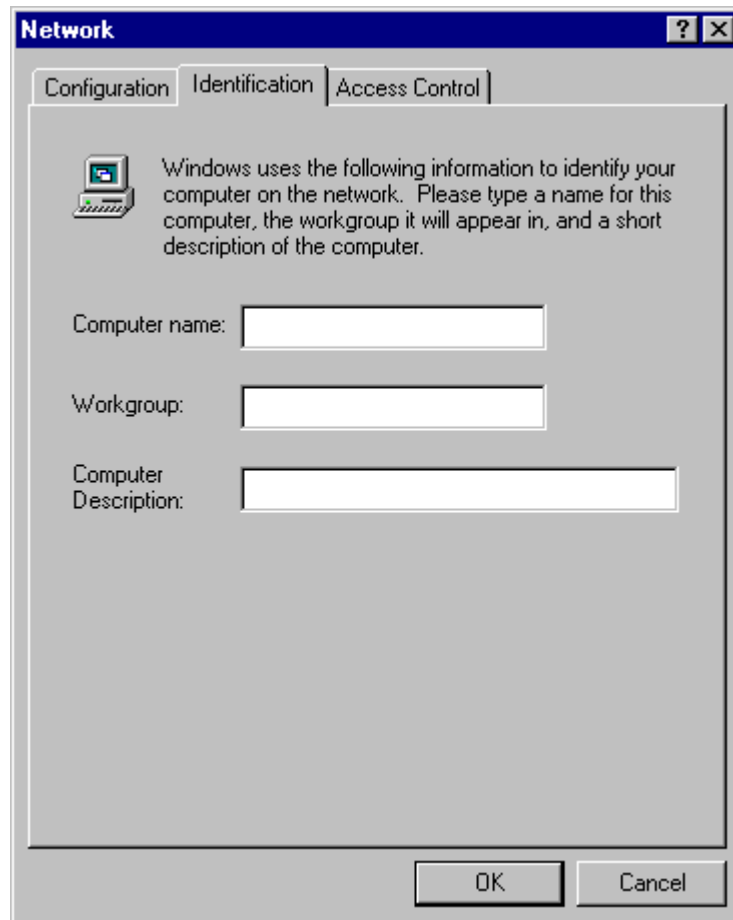

**Access****Windows 95/98:**

1. In the **Network** dialog box, click the **Access Control** tab.
2. Select **Share-Level access control**.



3. Click **OK** twice to return to, and then close, the **Network** dialog box.
- Note:** You must restart your system for the new settings to take effect. Once your machine has restarted, you may continue the configuration process.

## Make Your New Connection (NT Server Connection)

### Windows 95/98:

1. Double-click **My Computer**.
2. Double-click the **Dial-Up Networking** folder.
3. Double-click **Make New Connection** (or **Add New Connection**, Win98).
4. Follow the on-screen instructions to configure your connection.

### Windows NT:

1. Double-click **My Computer**.
2. Double-click **Dial-Up Networking**.
3. When the **Dial-Up Networking** dialog box opens, click **Install**.
4. Follow the on-screen instructions to configure your connection.

## Set Dial-up type (NT Server Connection)

### Windows 95/98:

1. **Right-click** the newly created connection icon, then click **Properties**; the **My Connection** dialog box opens.
2. On the **General** tab, click **Server Type**. The **Server Types** dialog box opens. Select **PPP: Windows 95, Windows NT 3.5, Internet**.
3. Select only the following check boxes: **Log on to network**, **Enable software compression**, and **TCP/IP**. Do not change any other check boxes that are already selected.

## Dial into Your Network (NT Server Connection)

### Windows 95/98:

1. You are ready to dial in to your network.
2. Double-click the **new connection** icon. The **Connect To** dialog box opens.
3. Enter the user name (if necessary) and password configured for you on the RF802EW.  
**Note:** If your particular situation permits, select the **Save password** check box.
4. Click **Connect**.
5. After connecting to the RF802EW, you can access the same services and resources as if you were connected to the network locally.

---

**Note: From this point forward in this section, screen shots will not be included. They would only repeat the ones on the preceding pages.**

---

## Accessing a Novell Server

Novell NetWare products are used on up to 70 percent of PC-based local area networks (LANs). Perform the following procedures when you need to connect your PC workstation to a remote Novell Server.

### Adding the dial-up adapter (Novell Server Connection)

#### Windows 95/98:

1. Click **Start | Settings | Control Panel**.
2. Double-click the **Network** icon to open the **Network** dialog box.
3. Click **Add**. The **Select Network Component Type** dialog box opens.
4. Select **Adapter**, then click **Add**. The **Select Network adapters** dialog box opens.
5. In the **Manufacturers** list, select **Microsoft**. In the **Network Adapters** list select **Dial-up adapter**.
6. Click **OK** twice to return to, and then close, the **Network** dialog box.

#### Windows NT:

Dial-up Networking adds PPP and SLIP protocol support, enabling your workstation to gain access to a remote computer or network, even if your computer is not on a network.

1. Double-click **My Computer**, then double-click **Dial-Up Networking**. The following screen is displays:
2. Click **Install**, then follow the on-screen instructions to configure your connection.

### Adding IPX/SPX (Novell Server Connection)

#### Windows 95/98:

1. In the **Network** dialog box, **Configuration** tab, click **Add**. The **Select Network Component Type** dialog box opens.
2. Select **Protocol** and click **Add**. The **Select Network Protocol** dialog box opens.
3. In the **Manufacturers** list, select **Microsoft**. In the **Network Protocols** list, select **IPX/SPX-compatible Protocol**.
4. Click **OK** twice to return to, and then close, the **Network** dialog box.

#### Windows NT:

**Note:** NWLink IPX/SPX Compatible Transport is probably already installed, along with NWLink NetBIOS and TCP/IP Protocol. However, if NWLink IPX/SPX Compatible Transport does not appear on the **Protocols** tab of the **Network** dialog box, perform the following steps:

1. In the **Network** dialog box, **Protocol** tab, click **Add**. The **Select Network Protocol** dialog box opens.
2. Select **NWLink IPX/SPX Compatible Transport**, then click **OK** to return to the **Network** dialog box.
3. Click **Close** to close the **Network** dialog box and return to the Desktop.



## Adding Client for NetWare Networks (Novell Server Connection)

### Windows 95/98:

1. In the **Network** dialog box, **Configuration** tab, click **Add**.
2. Select **Network Client** and click **Add**.
3. The **Select Network Client** dialog box displays. In the **Manufacturer's** list, select **Microsoft**. In the **Network Clients** list, select **Client for NetWare Networks**.
4. Click **OK** to add this Client and return to the **Network** dialog box.

## Set Up Properties of Components (Novell Server Connection)

### Network Client

#### Windows 95/98:

1. In the **Network** dialog box, **Configuration** tab, select **Client for Microsoft Networks**.
2. Click **Properties**. The **Client for Microsoft Networks Properties** dialog box opens.
3. On the **General** tab, select the **Log on to Windows NT domain** check box.
4. Enter the name of your Windows NT domain, as provided by your Network Administrator in the **Windows NT domain** box.
5. Click **OK** to return to the **Network** dialog box.
6. In the **Network** dialog box, **Configuration** tab, select **Client for NetWare Networks**.
7. Click **Properties**.
8. On the **General** tab, in the **Preferred server** box, enter the name of your Novell Server Domain. If necessary, select the **First Network Drive**, then verify that the **Enable logon script processing** check box is selected. (It's the default.)
9. Click **OK** to return to the **Network** dialog box.

## Set Your Primary Network Logon

### Windows 95/98:

1. In the **Network** dialog box, **Configuration** tab, select **Client for NetWare Networks** as the Primary Network Logon.
2. Click **OK**. You are returned to the Desktop.

## Set Your Access Control (Novell Server Connection)

### Windows 95/98:

1. In the **Network** dialog box, select the *Access Control* tab.
2. In the **Control Access to shared resources using** list, select **Share-Level Access Control**.

**Note:** You must restart your system for the new settings to take effect.

## Make Your New Connection (Novell Server Connection)

### Windows 95/98:

1. Double-click **My Computer**.
2. Double-click the **Dial-Up Networking** folder.
3. Double-click **Make New Connection** (or **Add New Connection**, Win98).
4. Follow the on-screen instructions to configure your connection.

### Windows NT:

1. Double-click **My Computer**.
2. Double-click **Dial-Up Networking**.
3. When the **Dial-Up Networking** dialog box opens, click **Install**.
4. Follow the on-screen instructions to configure your connection.

## Set Dial-up type (Novell Server Connection)

### Windows 95/98:

1. **Right-click** the newly created connection icon, then click **Properties**; the **My Connection** dialog box opens.
2. On the **General** tab, click **Server Type**. The **Server Types** dialog box opens. Select **PPP: Windows 95, Windows NT 3.5, Internet**.
3. Select only the **Log on to network**, **Enable software compression**, and **TCP/IP** check boxes. Do not change any other check boxes that are already selected.

## Dial into your network (Novell Server Connection)

### Windows 95/98:

1. You are ready to dial in to your network.
2. Double-click the **new connection** icon. The **Connect To** dialog box opens.
3. Enter the user name (if necessary) and password configured for you on the RF802EW.

**Note:** If your particular situation permits, select the **Save password** check box.

4. Click **Connect**.
5. After connecting to the RF802EW, you can access the same services and resources as if you were connected to the network locally.

## Accessing a Windows NT Server and a Novell NetWare Server

**Note:** Before configuring your remote site, ensure TCP/IP has been installed on your NT Server.

Perform the following procedures if your PC workstation needs to access **both** a Windows NT Server and a Novell NetWare Server.

### Adding the dial-up adapter (Novell/NT Server Connection)

**Windows 95/98/NT:**

1. Click **Start | Settings | Control Panel**.
2. Double-click the **Network** icon to open the **Network** dialog box.
3. Click **Add**. The **Select Network Component Type** dialog box opens.
4. Select **Adapter**, then click **Add**. The **Select Network adapters** dialog box opens.
5. (Win95/98 only) In the **Manufacturers** list, select **Microsoft**. In the **Network Adapters** list select **Dial-up adapter**.

**Note:** In Windows NT workstation there is no **Manufacturers** list.

6. Click **OK** twice to return to, and then close, the **Network** dialog box.

### Adding TCP/IP (Novell/NT Server Connection)

**Windows 95/98/NT:**

1. In the **Network** dialog box, **Configuration** tab, click **Add**.
2. Select **Protocol** and click **Add**.
3. The **Select Network Protocol** dialog box is displayed. In the **Manufacturers** list [Win95 only], select **Microsoft**. In the **Network Protocols** list, select **TCP/IP** [Win95/98] or **TCP/IP Protocol** [WinNT only].

**Note:** Windows NT workstation has no **Manufacturers** list.

4. Click **OK** twice to return to, and then close, the **Network** dialog box.

### Adding Client for Microsoft Networks (Novell/NT Server Connection)

**Windows 95/98:**

1. In the **Network** dialog box, **Configuration** tab, click **Add**.
2. Select **Network Client** and click **Add**.
3. The **Select Network Client** dialog box displays. In the **Manufacturer's** list, select **Microsoft**. In the **Network Clients** list, select **Client for Microsoft Networks**.
4. Click **OK** to add this Client and return to the **Network** dialog box.

## Adding File and Print Sharing for Microsoft Networks (Novell/NT Server Connection)

### Windows 95/98:

1. In the **Network** dialog box, **Configuration** tab, click **Add**.
2. Select **Services** and click **Add**.
3. The **Select Network Service** dialog box displays. In the **Manufacturers** list, select **Microsoft**. Select **File and Printer sharing for Microsoft Networks**.  
**Note:** Windows 98 has no **Manufacturers** list.
4. Click **OK** twice to return to, and then close, the **Network** dialog box.

## Adding IPX/SPX (Novell/NT Server Connection)

### Windows 95/98:

1. In the **Network** dialog box, **Configuration** tab, click **Add**. The **Select Network Component Type** dialog box opens.
2. Select **Protocol** and click **Add**. The **Select Network Protocol** dialog box opens.
3. In the **Manufacturers** list, select **Microsoft**. In the **Network Protocols** list, select **IPX/SPX-compatible Protocol**.
4. Click **OK** twice to return to, and then close, the **Network** dialog box.

### Windows NT:

- Note:** NWLink IPX/SPX Compatible Transport is probably already installed, along with NWLink NetBIOS and TCP/IP Protocol. However, if NWLink IPX/SPX Compatible Transport does not appear on the Protocols tab of the **Network** dialog box, perform the following steps:
1. In the **Network** dialog box, **Protocol** tab, click **Add**. The **Select Network Protocol** dialog box opens.
  2. Select **NWLink IPX/SPX Compatible Transport**, then click **OK** to return to the **Network** dialog box.
  3. Click **Close** to close the **Network** dialog box and return to the Desktop.

## Adding Client for NetWare Networks (Novell/NT Server Connection)

### Windows 95/98:

1. In the **Network** dialog box, **Configuration** tab, click **Add**.
2. Select **Network Client** and click **Add**.
3. The **Select Network Client** dialog box displays. In the **Manufacturer's** list, select **Microsoft**. In the **Network Clients** list, select **Client for NetWare Networks**.
4. Click **OK** to add this Client and return to the **Network** dialog box.

## Set Your Primary Network Logon (Novell/NT Server Connection)

### Windows 95/98:

1. In the **Primary Network Logon** list on the **Configuration** tab of the **Network** dialog box, select (the previously installed) **Client for Microsoft Networks**.
2. Click **OK** to close the **Network** dialog box.

## Set Up Properties of Components (Novell/NT Server Connection)

### Dial-up Adapter

#### Windows 95/98

1. In the **Network** dialog box, **Configuration** tab, select the **TCP/IP - Dial-up adapter**.
2. Click **Properties**. The **TCP/IP Properties** dialog box opens with the **IP Address** tab selected.
3. Ensure that **Obtain an IP Address Automatically** is selected. (It's the default.)
4. Click **OK** to close the **TCP/IP Properties** dialog box.

### Network Client

#### Windows 95/98:

1. In the **Network** dialog box, **Configuration** tab, select **Client for Microsoft Networks**.
2. Click **Properties**. The **Client for Microsoft Networks Properties** dialog box opens.
3. On the **General** tab, select the **Log on to Windows NT domain** check box.
4. Enter the name of your Windows NT domain, as provided by your Network Administrator in the **Windows NT domain** box.
5. Click **OK** to return to the **Network** dialog box.
6. In the **Network** dialog box, **Configuration** tab, select **Client for NetWare Networks**.
7. Click **Properties**.
8. On the **General** tab, in the **Preferred server** box, enter the name of your Novell Server Domain. Select the **First Network Drive** and **Enable Logon Script processing**.
9. Click **OK**.

### Network Protocol

#### Windows 95/98:

1. In the **Network** dialog box, **Configuration** tab, select **IPX/SPX Compatible Protocol**.
2. Click **Properties**.
3. Disable **Client for Microsoft Networks** and **File and Printer Sharing for Microsoft Networks**. This will ensure that when you log into your NT server, Windows will use the TCP/IP protocol. Next, you must enable **Client for Microsoft Networks**.

## Set Your Identification

### Windows 95/98:

1. In the **Network** dialog box, click the **Identification** tab.
2. In the **Workgroup** box, enter the name of your NT domain or the name of your workgroup as provided by your Network Administrator.
3. Enter a name and description for your computer.
4. Click **OK**.

## Set Your Access Control

### Windows 95/98:

1. In the **Network** dialog box, select the **Access Control** tab.
2. Select the **Share-Level access control** option.
3. Click **OK** twice to return to, and then close, the **Network** dialog box.

**Note:** You must restart your system for the new settings to take effect. Once your machine has restarted, you may continue the configuration process.

## Make Your New Connection (NT/Novell Server Connection)

### Windows 95/98:

1. Double-click **My Computer**.
2. Double-click the **Dial-Up Networking** folder.
3. Double-click **Make New Connection** (or **Add New Connection**, Win98).
4. Follow the on-screen instructions to configure your connection.

### Windows NT:

1. Double-click **My Computer**.
2. Double-click **Dial-Up Networking**.
3. When the **Dial-Up Networking** dialog box opens, click **Install**.
4. Follow the on-screen instructions to configure your connection.

## Set Dial-up type (NT/Novell Server Connection)

### Windows 95/98:

1. **Right-click** the newly created connection icon, then click **Properties**; the **My Connection** dialog box opens.
2. On the **General** tab, click **Server Type**. The **Server Types** dialog box opens. Select **PPP: Windows 95, Windows NT 3.5, Internet**.
3. Select only the **Log on to network**, **Enable software compression**, and **TCP/IP** check boxes. **Note:** do not disturb any other items that are already checked.

## Dial into your network (NT/Novell Server Connection)

### Windows 95/98:

1. You are ready to dial in to your network.
2. Double-click the **new connection** icon. The **Connect To** dialog box opens.
3. Enter the user name (if necessary) and password configured for you on the RF802EW.  
**Note:** If your particular situation permits, select the **Save password** check box.
4. Click **Connect**.
5. After connecting to the RF802EW, you can access the same services and resources as if you were connected to the network locally.

## Accessing a Unix Server

Perform the following procedures to prepare your PC workstation to access a remote Unix Server.

### Adding the dial-up adapter (Unix Server Connection)

#### Windows 95/98/NT:

1. Click **Start** | **Settings** | **Control Panel**.
2. Double-click the **Network** icon to open the **Network** dialog box.
3. Click **Add**. The **Select Network Component Type** dialog box opens.
4. Select **Adapter**, then click **Add**. The **Select Network adapters** dialog box opens.
5. In the **Manufacturers** list, select **Microsoft**. In the **Network Adapters** list, select **Dial-up adapter**.
6. Click **OK** twice to return to, and then close, the **Network** dialog box.

#### Windows NT:

Dial-up Networking adds PPP and SLIP protocol support, enabling your workstation to gain access to a remote computer or network, even if your computer is not on a network.

1. Double-click **My Computer**, then double-click **Dial-Up Networking**. The following message displays:
2. Click **Install**, then follow the on-screen instructions to configure your connection.

### Adding TCP/IP (Unix Server Connection)

#### Windows 95/98/NT:

1. In the **Network** dialog box, **Configuration** tab, click **Add**.
2. Select **Protocol** and click **Add**.
3. The **Select Network Protocol** dialog box is displayed. In the **Manufacturers** list [Win95 only], select **Microsoft**. In the **Network Protocols** list, select **TCP/IP** [Win95/98] or **TCP/IP Protocol** [WinNT only].  
**[Note:** Windows NT workstation has no **Manufacturers** list.]
4. Click **OK** twice to return to, and then close, the **Network** dialog box.

### Set Up Properties of Components (Unix Server Connection)

#### Dial-up Adapter

#### Windows 95/98:

1. In the **Network** dialog box, **Configuration** tab, select the **TCP/IP - Dial-up adapter**.
2. Click **Properties**. The **TCP/IP Properties** dialog box opens.
3. Ensure that **Obtain an IP Address Automatically** is selected. (It's the default.)
4. Click **OK** to close the **TCP/IP Properties** dialog box.

**Note:** You must restart your machines to enable the new settings.



## Make Your New Connection (Unix Server Connection)

### Windows 95/98:

1. Double-click **My Computer**.
2. Double-click the **Dial-Up Networking** folder.
3. Double-click **Make New Connection** (or **Add New Connection**, Win98).
4. Follow the on-screen instructions to configure your connection.

### Windows NT:

1. Double-click **My Computer**.
2. Double-click **Dial-Up Networking**.
3. When the **Dial-Up Networking** dialog box opens, click **Install**.
4. Follow the on-screen instructions to configure your connection.

## Set Dial-up type (Unix Server Connection)

### Windows 95/98:

1. **Right-click** the newly created connection icon, then click **Properties**; the **My Connection** dialog box opens.
2. On the **General** tab, click **Server Type**. The **Server Types** dialog box opens. Select **PPP: Windows 95, Windows NT 3.5, Internet**.
3. Select only the **Log on to network**, **Enable software compression**, and **TCP/IP** check boxes. **Note:** do not change any other items that are already selected.

## Dial into your network (Unix Server Connection)

### Windows 95/98:

1. You are ready to dial in to your network.
2. Double-click the **new connection** icon. The **Connect To** dialog box opens.
3. Enter the user name (if necessary) and password configured for you on the RF802EW.

**Note:** If your particular situation permits, select the **Save password** check box.

4. Click **Connect**.
5. After connecting to the RF802EW, you can access the same services and resources as if you were connected to the network locally.

## Make New Connection (Windows 2000 only)

Perform the following procedures to prepare your Windows 2000 PC workstation to access any of the remote Servers and enable applications such as email, Web browsing, file sharing, and printing.

1. Double-click **My Computer**.
2. Double-click the **Network and Dial-up Connections** folder.

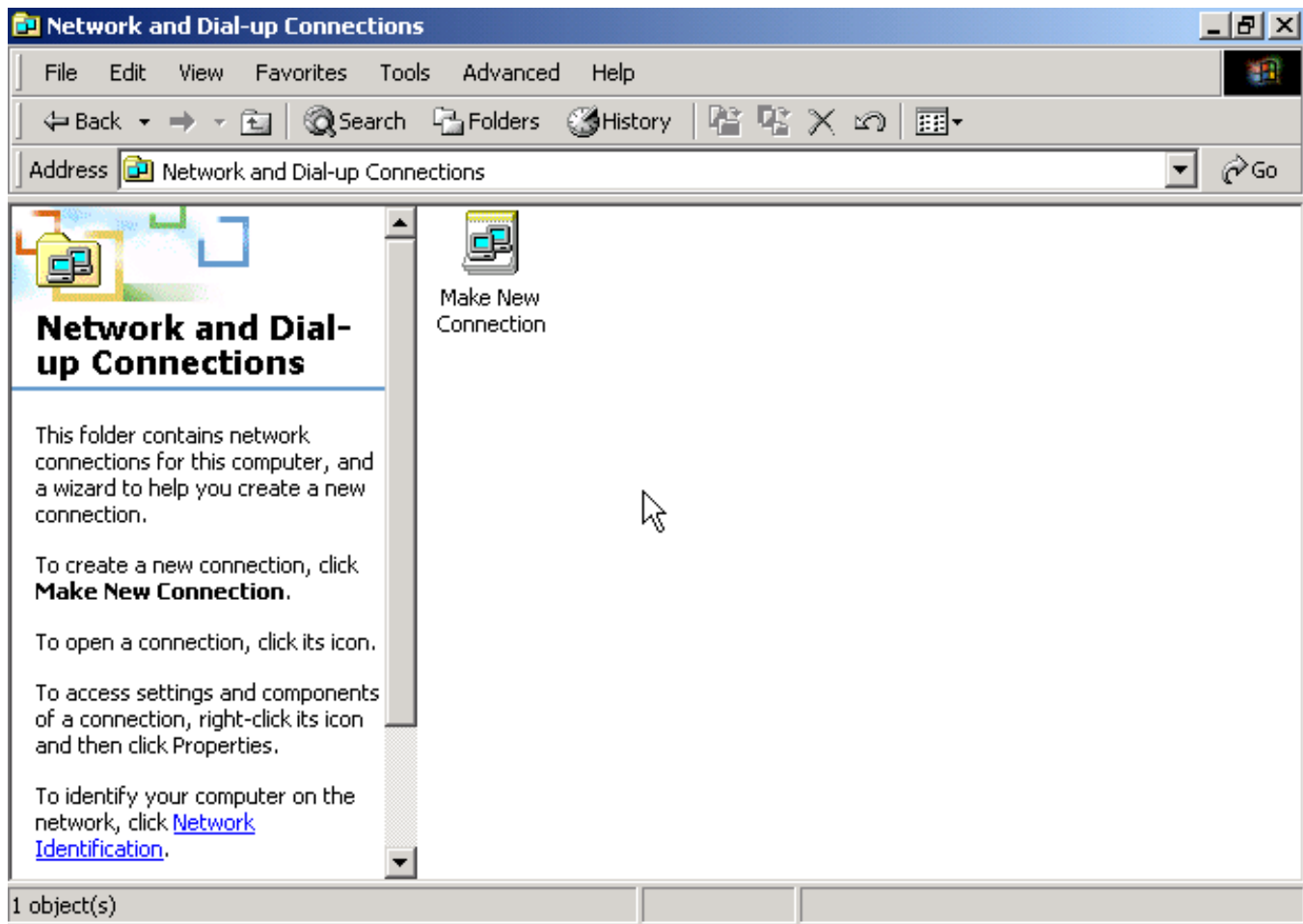

3. Double-click **Make New Connection**.



4. Click **Next**, then follow the on-screen instructions to configure your connection.

---

*RouteFinder*<sup>™</sup>

**Chapter 9**  
**LAN-to-LAN Settings**

---

## Chapter 9 - LAN-to-LAN Settings

### Setting up LAN-to-LAN Routing

The majority of settings for LAN-to-LAN Routing are set up through RouteFinder Wizard or RouteFinder Manager when IP routing (NAT disabled) is configured. This section provides an overview of LAN -to- LAN Routing and shows you some of the benefits and limitations of LAN-to-LAN Routing.

### Setting up a Windows machine to share files

If you would like to share files over your network but don't want to install a Windows NT server, you can enable the file sharing feature of Windows. To set up file sharing:

**Note:** Each computer that you wish to share files among must be within the same workgroup. Use the **Identification tab** of the Network Dialog box to define a workgroup name.

1. Select **Start | Settings | Control Panel**.
2. Click **Network**.
3. Click **File and Printer Sharing**.
4. To enable file sharing, select the **I want to be able to give others access to my files** check box.
5. If you haven't already done so, ensure that this computer has a fixed IP address on your local network. Refer to the LAN Client Settings chapter for information on configuring a fixed IP address.
6. After configuring and activating the fixed IP address, using **My Computer** or **Windows Explorer**, **right click** the file or drive on the computer that you would like to share.
7. Select **Sharing**.
8. Enable sharing by selecting **Shared As**. Enter the name by which you would like this file or drive to be known on your network.
9. You may now share the files on this computer.

## Using the Find Computer Command

If your clients are in different subnets or separated by a router, you will not be able to use the Find Computer function within Windows by selecting **Start | Find | Computer**.

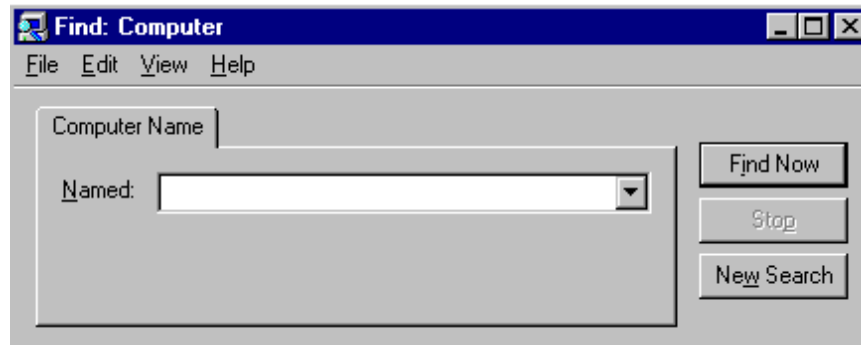

In the **Find Computer** dialog box, type the IP address of the computer you would like to find in the **Named** box. If you choose a computer on a remote network, the network device will attempt to establish a dial-up connection to the remote LAN based on settings entered in RouteFinder manager. If you have entered the computer's IP address and host name into your LMHosts file, you may enter the computer's host name, rather than the IP address in the **Named** box (refer to the following LMHosts section of this User Guide).

**Note:** If the computer you are attempting to access is on a remote LAN, you may need to press **Find Now** more than once while you wait for your network device to establish a dial-up connection to your remote LAN.

## Using LMHosts

**Important:** Each computer on the LAN must have a copy of this lookup table. Once you have mapped the necessary computer or host names and IP addresses in the LMHosts file, copy this file to the appropriate folder on each computer on the LAN. This file is located in your x:\Windows folder, where x: is the drive letter associated with the location of your windows operating system. Use Windows Explorer, **Tools | Find | Files or Folders** option to search for LMHosts.

The LMHosts file can be edited using a text editor such as **Notepad**. At the end of the file, enter the IP address, followed by a space, then the host or computer name. Add all necessary IP addresses and computer names to the LMHosts file and save the file.

Once the LMHost file has been copied to each computer, the user will be able to enter the name of the computer they want to access on the LAN without having to remember the IP address.

When using **Find Computer**, you may enter either an IP address or the computer's host name if you have entered the name and IP address in your LMHosts lookup table.

**Note:** Since the computers you will add to the LMHosts file are generally servers, only computers with fixed IP addresses should be added to this file.

---

*RouteFinder*<sup>™</sup>

**Chapter 10**  
**Troubleshooting**

---

## Chapter 10 - Troubleshooting

This chapter provides a list of common problems encountered while installing, configuring or administering the RF802EW. In the event you are unable to resolve your problem, refer to the Service, Warranty and Technical Support chapter of this User Guide for information about contacting our Technical Support representatives.

### Problem #1

#### **My computer can't detect my RouteFinder on the LAN when I start one of the RouteFinder Utilities (Device Not Found).**

- Try clicking **Refresh Device List**.
- Unplug your network device and plug it back in, then press **Refresh Device List**.
- Ensure your computer has TCP/IP properly configured. You can check this by trying to "ping" the computer you are using. If you can successfully ping the computer from itself, the computer has TCP/IP correctly installed. Once you determine that you are able to ping the computer, try to ping another computer in the same segment of your network. If this ping is successful, your computer is properly connected to the network.
- Remove the TCP/IP Dial-up Adapter from your computer. For instructions, see **Problem #2** in this section.
- Ensure your network device is properly connected to your Ethernet hub by pressing **Refresh Device List** in either **RouteFinder Manager** or **RouteFinder Monitor**. If your RouteFinder is correctly connected, the WAN indicator light on your RouteFinder will flash. If no flash occurs, it is not properly connected to the network. Reconnect your network device to the hub and try again. If there is still no flash, it is possible the Ethernet cable or hub has a problem.

### Problem #2

#### **Other computers can connect to the network device, but my computer can't.**

Whenever I click on Internet Explorer or Netscape, I see the Windows Dial-up utility popping up on my screen asking for my phone number and password to dial-up my ISP.

- Remove the TCP/IP dial-up adapter from all computers that will be using your RouteFinder to access the Internet. TCP/IP dial-up adapter is not needed to use the RF802EW to connect to the Internet.
  1. To remove the **Dial-up Adapter**, click **Start | Settings | Control Panel**.
  2. Double-click the **Network** icon.
  3. Click the **Dial-up Adapter** and press **Remove**. Restart the computer and try again.
- Ensure you have a correct IP address. From a DOS window in Windows 95/98, type **winipcfg**. From Windows NT, type **ipconfig**. If the address is listed as 0.0.0.0, the computer does not have an IP address and you must ensure the automatic DHCP configuration has been correctly set up for this computer.
- Ensure that the Web browser is properly configured to connect to the Internet via the LAN.



**Problem #3****The RouteFinder is connected to the Cable/DSL, but has problems accessing the Internet.**

- Ensure the workstation has TCP/IP properly configured.
- Attempt to ping the IP address of the RF802EW.
- Use **RouteFinder Monitor** to see if the WAN Ethernet port has successfully acquired a dynamic IP address from the ISP, or if the static IP address is valid.
- Use **Winipcfg** (Windows 95/98) or **ipconfig** (Windows NT/ 2000) to check to see if the computer's IP settings are correct.
- Ensure the DNS settings are correct.
- Ensure the Gateway IP address is the device's LAN Ethernet IP address (Server IP address).
- Ensure the IP address netmask is correct.

**Problem #4****When I install the RouteFinder Utilities, I get the error message "missed export file oleaut32.dll"**

If you are using Windows 95/98, your computer has an old version of **oleaut32.dll**.

- Download the newest version of **oleaut32.dll** from the Microsoft web site (<http://www.microsoft.com>).
- Create a backup of the file **c:\windows\system\oleaut32.dll**.
- Copy the new file to **c:\windows\system\oleaut32.dll**.
- After you have successfully copied the file, reinstall the RouteFinder Utilities.
- If you have problems with the new oleaut.dll file, use the backup file.

**Problem #5****I configured my RouteFinder but I can't get it to communicate with my modem.**

- Check your initialization string. If you are using an ISDN TA and your ISDN TA was not listed as a choice in Setup Wizard, refer to the ISDN TA User Guide for the appropriate initialization string.
- After ensuring that the initialization string is correct, use the on-line help in RouteFinder Monitor.

**Problem #6****My RouteFinder dials-up a connection, but can't seem to communicate with the ISP.**

- Verify that your baudrate is not set too high for your modem or ISDN TA. The maximum baudrate that your modem or ISDN claims it can achieve may not be attainable due to poor line or connection quality. Use RouteFinder Manager's Modem settings menu to correct set the baudrate to a lower rate and retry the connection.
- After lowering the baudrate, you are still not able to establish a connection, use the RouteFinder Monitor's on-line help. If your connection still doesn't work, contact your ISP.

**Problem #7**

**Sometimes when I try and use the Internet or get my mail, the application can't connect to the Internet immediately.**

- The most common reason for this is not due to a problem or error. If you are the first person to make a connection to the Internet through the RF802EW, there will be a delay when the Dial-On-Demand function automatically makes the connection and logs on to your ISP. Subsequent users will be able to use the connection you've established without a delay.
- If the scenario described above does not fit your situation, use RouteFinder monitor to view all events that are taking place between the modem and your ISP as you attempt to make a connection (a busy signal).

**Problem #8**

**After installing my RF802EW, my modem connection seems to be slower.**

- The RouteFinder device should have no effect on the modem speed. However, if more than one client is using the same modem through the RouteFinder, the speed will be reduced.
- Run **RouteFinder Monitor** to view the number of concurrent client connections to your ISP.

**Problem #9**

**While the Serial async port is in use, my RF802EW keeps dialing a connection to the Internet, but no one is using the Internet.**

- The RF802EW will only dial the connection if there is a request from one of the computers on the LAN for an IP address on the Internet. Keep in mind that certain applications can be configured to request information from the Internet. For example, Microsoft Outlook can be set up to "check for new mail every x minutes". If this feature is enabled, Outlook will send a request for your Internet POP3 server which will cause your RF802EW to dial-up your ISP. To determine which computer on your network is processing a request for an Internet connection, use the **RouteFinder Monitor**. The event messages will provide information about which computer is causing the RF802EW to dial and which service (port#) the computer is requesting.

**Problem #10**

**The "Please set the Device IP" screen displays when configuring the RF802EW.**

- This system detects that the RouteFinder's LAN Ethernet IP address is not in the same subnet as the PCs. Use RouteFinder Manager to set the RouteFinders' IP address to the same network as your PC's.

**Problem #11**

**A message appears indicating the IP address you have inputted is either not valid on your network or is in conflict with another IP address.**

- The manager has detected the IP address of the RF802EW you are configuring is in conflict with another device. Power off the conflicting device and configure the RF802EW using a different Ethernet LAN IP address.

---

*RouteFinder*<sup>™</sup>

**Chapter 11**  
**Service, Warranty**  
**and Technical Support**

---

## Chapter 11- Service, Warranty, and Technical Support

This chapter begins with the terms of your RouteFinder's warranty. In the Software User License Agreement section, you will find details about your software license agreement with Multi-Tech Systems. The Technical Support section offers information about on-line registration as well as phone numbers for contacting our Technical Support group. Also included in this chapter is information about accessing our Internet site, and information about ordering accessories for your RouteFinder.

### Limited Warranty

Multi-Tech Systems, Inc., (hereafter "MTS") warrants that the RouteFinder will be free from defects in material or workmanship for a period of two years from date of purchase, or if proof of purchase is not provided, two years from date of shipment.

MTS MAKES NO OTHER WARRANTY, EXPRESS OR IMPLIED, AND ALL IMPLIED WARRANTIES OF MERCHANTABILITY AND FITNESS FOR A PARTICULAR PURPOSE ARE HEREBY DISCLAIMED.

This warranty does not apply to any products which have been damaged by lightning storms, water, or power surges or which have been neglected, altered, abused, used for a purpose other than the one for which they were manufactured, repaired by Customer or any party without MTS's written authorization, or used in any manner inconsistent with MTS's instructions.

MTS's entire obligation under this warranty shall be limited (at MTS's option) to repair or replacement of any products which prove to be defective within the warranty period or, at MTS's option, issuance of a refund of the purchase price. Defective products must be returned by Customer to MTS's factory — transportation prepaid.

MTS WILL NOT BE LIABLE FOR CONSEQUENTIAL DAMAGES, AND UNDER NO CIRCUMSTANCES WILL ITS LIABILITY EXCEED THE PRICE FOR DEFECTIVE PRODUCTS.

### Addendum for North American Products

In the event that service is required, products may be shipped, freight prepaid, to our Mounds View, Minnesota, factory (**Multi-Tech Systems, Inc., 2205 Woodale Drive, Mounds View, MN 55112, Attn: Repairs, Serial #\_\_\_\_\_**). A Returned Materials Authorization (RMA) is not required. Return shipping charges (surface) will be paid by MTS. Please include, inside the shipping box, a description of the problem, a return shipping address (must have street address, not P.O. Box), a telephone number, and if the product is out of warranty, a check or purchase order for repair charges.

Extended two-year overnight replacement agreements are available for selected products. Please refer to our Overnight Replacement Agreement on our web site for details on rates and coverages. Please direct your questions regarding technical matters, product configuration, verification that the product is defective, etc., to our Technical Support department at **1-800-972-2439**.

Please direct your questions regarding repair expediting, receiving, shipping, billing, etc., to our Repair Accounting department at **(800) 328-9717** or **(763) 785-3500**.

Repairs for damages caused by lightning storms, water, power surges, incorrect installation, physical abuse, or user-caused damages are billed on a time-plus-materials basis.

## **Addendum for International Products**

Distributors should contact Amex, Inc., for information about the repairs for your Multi-Tech product.

Amex, Inc.  
2724 Summer Street NE Minneapolis, MN 55413  
U.S.A. Tel: +(612) 331-3251  
Fax: +(612) 331-3180

Please direct your questions regarding technical matters, product configuration, verification that the product is defective, etc., to our Technical Support department nearest you. When calling the U.S., please direct your questions regarding repair expediting, receiving, shipping, billing, etc., to our Repair Accounting department at **+(763) 785-3500** in the U.S.A., or a nearby Multi-Tech office which is listed on the "Multi-Tech Corporate Offices" sheet in this International Distributor Resource Kit.

Repairs for damages caused by lightning storms, water, power surges, incorrect installation, physical abuse, or user-caused damages are billed on a time-plus-materials basis.

## **Out of Warranty Repair Costs**

Refer to Multi-Tech System's web site at <http://www.multitech.com> for information about out of warranty repair costs.

---

# Software User License Agreement

## **IMPORTANT - READ BEFORE OPENING THE SOFTWARE PACKAGE**

This license agreement is a legal agreement between you (either an individual or a single entity) and Multi-Tech Systems, Inc. for the Multi-Tech software product enclosed, which includes computer software and may include associated media, printed materials, and “online” or electronic documentation (“SOFTWARE PRODUCT”). The SOFTWARE PRODUCT also includes any updates and supplements to the original SOFTWARE PRODUCT provided to you by Microsoft. Any software provided along with the SOFTWARE PRODUCT that is associated with a separate end-user license agreement is licensed to you under the terms of that license agreement.

By installing, copying, downloading, accessing, or otherwise using the SOFTWARE PRODUCT, you agree to be bound by the terms of this End User License Agreement (EULA). If you do not agree to the terms of this EULA, do not install or use the SOFTWARE PRODUCT; you may, however, return it to your place of purchase for a full refund.

## **SINGLE-USER SOFTWARE LICENSE AGREEMENT**

This copy of Multi-Tech software is provided only on the condition that you, Customer, agree to the following license. READ THIS LICENSE CAREFULLY. If you do not agree to the terms contained in this license, return the packaged program UNOPENED to the place you obtained it. If you agree to the terms contained in this license, fill out the enclosed Software Registration Card, date, sign and return the card by mail. Opening the packaged program constitutes agreement to be bound by the terms and conditions of this Software License Agreement. Your right to use the software terminates automatically if you violate any part of this software license agreement.

## **MULTI-TECH SOFTWARE LICENSE AGREEMENT**

Multi-Tech Systems, Inc. (MTS) agrees to grant and Customer agrees to accept on the following terms and conditions, a non-transferable and non-exclusive license to use the software program(s) delivered with this Agreement.

1. **GRANT OF LICENSE.** MTS grants Customer the right to use one copy of the software on a single computer (the Licensed System). You may not network the software or otherwise use it on more than one computer or computer terminal at the same time.
2. **COPYRIGHT.** The software is owned by MTS and is protected by United States copyright laws and international treaty provisions. Therefore, Customer must treat the software like any copyrighted material. Customer may install the software to a single hard disk and keep the original for backup or archival purposes. Customer shall NOT copy, or translate into any language, in whole or in part, any documentation which is provided by MTS in printed form under this Agreement.
3. **OTHER RESTRICTIONS.** The software may not be assigned, sublicensed, translated or otherwise transferred by Customer without prior written consent from MTS. Customer may not reverse engineer, decompile, or disassemble the software. Any updates shall be used only on the Licensed System, and shall remain subject to all other terms of this Agreement. Customer agrees not to provide or otherwise make available the software including, but not limited to documentation, programs listings, object code, or source code, in any form, to any person other than Customer and his employees and /or agents, without prior written consent from MTS. Customer acknowledges that the techniques, algorithms, and processes contained in the software are proprietary to MTS and Customer agrees not to use or disclose such information except as necessary to use the software.

Customer shall take reasonable steps consistent with steps taken to protect its own proprietary information to prevent the unauthorized copying or use by third parties of the software or any of the other materials provided under this Agreement. Any previous version of the software must be destroyed or returned to Multi-Tech Systems, Inc. within 90 days of receipt of the software upgrade or update.

4. **WARRANTY.** MTS warrants that the software will perform substantially in accordance to the product specifications in effect at the time of receipt by Customer. If it fails to perform accordingly, MTS will optionally repair any defect, or replace it. This warranty is void if the failure has resulted from accident, abuse, or misapplication. A signed Software Registration Card must be on file at MTS for this warranty to be in effect.

THE FOREGOING WARRANTY IS IN LIEU ALL OTHER WARRANTIES, EXPRESSED OR IMPLIED, INCLUDING, BUT NOT LIMITED TO, THE IMPLIED WARRANTIES OF MERCHANTABILITY AND FITNESS FOR A PARTICULAR PURPOSE. IN NO EVENT WILL MTS BE LIABLE FOR CONSEQUENTIAL DAMAGES RESULTING FROM USE OF THE LICENSED PROGRAM, WHETHER AS A RESULT OF MTS NEGLIGENCE OR NOT, EVEN IF MTS HAS BEEN ADVISED OF THE POSSIBILITY OF SUCH DAMAGES.

5. **INDEMNIFICATION.** MTS will indemnify and defend Customer from any claim that the software infringes on any copyright, trademark, or patent. Customer will indemnify and defend MTS against all other proceedings arising out of Customers use of the software.
6. **GENERAL.** If any of the provisions, or portions thereof, of this Agreement are invalid under any applicable statute or rule of law, they are to that extent deemed to be omitted.

This is the complete and exclusive statement of the Agreement between the parties, which supersedes all proposals, oral, written and all other communications between the parties relating to the subject matter of this Agreement. This Agreement may only be amended or modified in writing, signed by authorized representatives of both parties.

This Agreement shall be governed by the laws of the State of Minnesota.

The waiver of one breach or default hereunder shall not constitute the waiver of any subsequent breach or default.

## Technical Support

Multi-Tech provides free technical support for as long as your product remains in service. Before calling Technical Support, please read through the Troubleshooting chapter of this User Guide. Also, ensure you have completed the Recording RouteFinder Information section below.

To contact our Technical Support group, use one of the following contact options, keeping in mind that phone calls are handled with first priority:

### Contacting Technical Support

|                      | ...Using email             | ...By phone                                      |
|----------------------|----------------------------|--------------------------------------------------|
| <b>France</b>        | support@multitech.fr       | +(33) 1-64 61 09 81                              |
| <b>India</b>         | support@multitechindia.com | +(91) 124-340778                                 |
| <b>U.K.</b>          | support@multitech.co.uk    | +(44) 118 959 7774                               |
| <b>Rest of World</b> | support@multitech.com      | 800-972-2439 (U.S. & Canada)<br>or +763-785-3500 |

### Recording RouteFinder Information

Before placing a call to our Technical Support staff, record the following information about your Multi-Tech RouteFinder.

**Model no.:** \_\_\_\_\_

**Serial no.:** \_\_\_\_\_

**Firmware version:** \_\_\_\_\_

**Software version:** \_\_\_\_\_

Note the status of your RouteFinder in the space provided before calling tech support. Make certain to include error messages, diagnostic test results, problems with a specific application, etc.

---



---



---



---



---

### Online Warranty Registration

If you have access to the World Wide Web, you can register your Multi-Tech product online at the following URL:

<http://www.multitech.com/register>



## About the Internet

Multi-Tech System's is a commercial provider on the Internet.

The Multi-Tech web site is located at <http://www.multitech.com>

The Multi-Tech FTP site is located at <ftp://ftp.multitech.com>

## Ordering Accessories

SupplyNet, Inc. can provide you with replacement transformers, cables and connectors for select Multi-Tech products. You can place an order with SupplyNet via mail, phone, fax or the Internet at:

**Mail:** SupplyNet, Inc.  
614 Corporate Way  
Valley Cottage, NY 10989

**Phone:** (800) 826-0279

**Fax:** (914) 267-2420

**Email:** [info@thesupplynet.com](mailto:info@thesupplynet.com)

**Internet:** <http://www.thesupplynet.com>

---

*RouteFinder*<sup>™</sup>

## **Appendixes**

**Appendix A**

**Appendix B**

**Appendix C**

---

## Appendix A - Regulatory Compliance Information

### Class B Statement FCC Part 15

This equipment has been tested and found to comply with the limits for a Class B digital device, pursuant to Part 15 of the FCC Rules. These limits are designed to provide reasonable protection against harmful interference in a residential installation. This equipment generates, uses and can radiate radio frequency energy and, if not installed and used in accordance with the instructions, may cause harmful interference to radio communications. However, there is no guarantee that interference will not occur in a particular installation. If this equipment does cause harmful interference to radio or television reception, which can be determined by turning the equipment off and on, the user is encouraged to try to correct the interference by one or more of the following measures:

- Reorient or relocate the receiving antenna.
- Increase the separation between the equipment and receiver.
- Connect the equipment into an outlet on a circuit different from that to which the receiver is connected.
- Consult the dealer or an experienced radio/TV technician for help.

This device complies with Part 15 of the FCC rules.

Operation is subject to the following two conditions:

- (1) This device may not cause harmful interference.
- (2) This device must accept any interference that may cause undesired operation.

**Warning:** Changes or modifications to this unit not expressly approved by the party responsible for compliance could void the user's authority to operate the equipment.

### Industry Canada

This Class B digital apparatus meets all requirements of the Canadian Interference-Causing Equipment Regulations.

Cet appareil numérique de la classe B respecte toutes les exigences du Règlement Canadien sur le matériel brouilleur.



### EMC and Safety Directive Compliance

The CE mark is affixed to this Multi-Tech product to confirm compliance with the following European Community Directives:

Council Directive 89/336/EEC of 3 May 1989 on the approximation of the laws of Member States relating to electromagnetic compatibility.

and

Council Directive 73/23/EEC of 19 February 1973 on the harmonization of the laws of Member States relating to electrical equipment designed for use within certain voltage limits:

each amended by Council Directive 93/68/EEC of 22 July 1993 on the harmonization of CE marking requirements.

---

## Appendix B - Tools for your RF802EW

### RouteFinder Monitor

If you are having problems, the RouteFinder Monitor can be a valuable tool to assist in troubleshooting. Additional troubleshooting information is available through the on-line help screens. Refer to Chapter 6 for more information about using the RouteFinder monitor.

### PING

Ping is an acronym for **P**acket **I**nternet **G**roper. The PING utility is used as a diagnostic tool to determine if a communication path exists between two devices on the network. The utility sends a packet to the specified address and then waits for a reply. PING is used primarily to troubleshoot Internet connections, but it can be used to test the connection between any devices using the TCP/IP protocol.

```
C:\>ping
Pinging 200.2.10.1 with 32 bytes of data:
Reply from 200.2.10.1: bytes=32 time<10ms TTL=128
Reply from 200.2.10.1: bytes=32 time<10ms TTL=128
Reply from 200.2.10.1: bytes=32 time<10ms TTL=128
Reply from 200.2.10.1: bytes=32 time<10ms TTL=128
C:\>
```

### WINIPCFG and IPCONFIG

There are two tools which are helpful in finding a computer's IP configuration, MAC address and default gateway.

#### WINIPCFG (for Windows 95/98)

1. Select **Start | Run** and type **winipcfg**.
2. The IP address, default gateway (the RF802EW IP address), and the MAC (adapter address) display.

**IPCONFIG** (for Window NT/2000)

1. From a DOS Prompt, type **IPCONFIG** and press **Enter**.
2. The IP address, default gateway (the RF802EW IP address), and the MAC (adapter address) display.

```
Microsoft(R) Windows NT(TM)
(C) Copyright 1985-1996 Microsoft Corp.

C:\>ipconfig

Windows NT IP Configuration

Ethernet adapter rl100b7:

 IP Address. : 200.2.10.1
 Subnet Mask : 255.255.255.0
 Default Gateway : 200.2.10.99

C:\>_
```

**TRACERT**

TRACERT is an extensive PING utility that allows you to trace the route of an IP address. The utility reports the number of router hops, the time for each hop, and any failed attempts to cross a hop. The information provided by this utility assists you to locate the specific site of a failed PING. You can run TRACERT at the DOS prompt (e.g., c:\tracert www.yahoo.com). The utility will provide information about the route and number of hops required to reach the destination IP address associated with the network address or URL.

# Appendix C - Cabling Diagrams

## WAN/LAN Cables

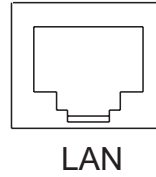
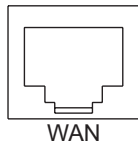

| Pin | Circuit Signal Name        |
|-----|----------------------------|
| 1   | TD+ Data Transmit Positive |
| 2   | TD- Data Transmit Negative |
| 3   | RD+ Data Receive Positive  |
| 6   | RD- Data Receive Negative  |

## Serial Cable

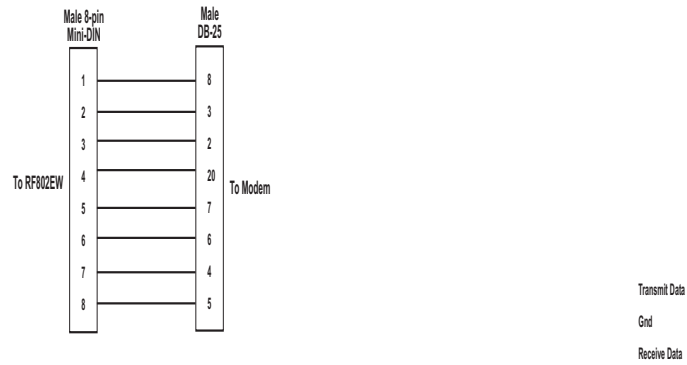
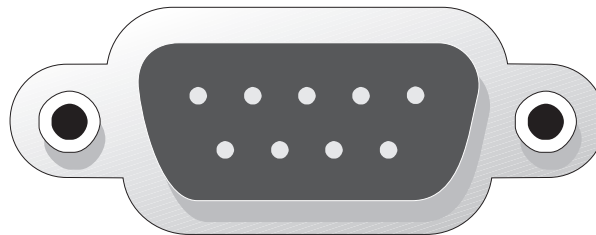

---

*RouteFinder*<sup>™</sup>

## Glossary

---

The following is a glossary of terms used in this manual:

**B****Baudrate**

Baudrate refers to the number of bits per second (Bps) that are transmitted between your network device and modem or ISDN TA.

**D****DHCP (Dynamic Host Configuration Protocol)**

A protocol that was made to lessen the administrative burden of having to manually configure TCP/IP Hosts on a network. DHCP makes it possible for every computer on a network to extract its IP information from a DHCP server instead of having to be manually configured on each network computer. The DHCP server built-in to your RouteFinder allows every computer on your network to automatically extract IP information from the RouteFinder.

Why is it called Dynamic?

Each time a network client turns on their computer your RouteFinder DHCP server will automatically give them an IP address from the IP address pool configured in the DHCP Configuration dialog box in RouteFinder Manager. It is called Dynamic because the address that is issued could be different each time a computer connects to the network.

**DNS (DomainNameSystem)**

A DNS Server can be thought of as the computer at your ISP whose job is to take all the URLs that you type into your web browser and translate them to their corresponding IP address. To use this the DNS translator, you need to know the IP address of your ISP's DNS Server.

**E****Ethernet**

A LAN (Local Area Network) protocol developed by Xerox and DEC. It is a very commonly used type of LAN.

**F****Firewall**

A system designed to prevent unauthorized access to or from a private network. Firewalls are typically installed to give users access to the Internet while protecting their Internal Information. Your RouteFinder uses a firewall technology known as NAT (see NAT). Each message entering or leaving the intranet passes through the firewall. The firewall examines each message and blocks those that do not meet the specified security criteria.

**Firmware**

Software that has been permanently or semi-permanently written to the RouteFinder's memory. Your RouteFinder supports flash ROM which means you can upgrade the firmware in your network device very easily by downloading a copy of the new firmware from the Multi-Tech web site and using the RouteFinder Manager Upgrade Firmware function.

**FTP (File Transfer Protocol)**

A protocol which allows a user on one host to access, and transfer files to and from another host over a network.

**I****IP (Internet Protocol)**

The Internet Protocol is the network layer for the TCP/IP Protocol Suite. It is a connectionless, best-effort packet switching protocol.

**Intranet**

An Intranet is the use of Internet technologies within a company. Intranets are private networks that exist only within organizations, while the Internet is a global network open to all.



---

## IP Addresses

A computer on the Internet is identified by an IP Address. A computer's IP address is like a telephone number. It identifies one address or in this case one computing device. Every computer or device on the network must have a different IP address.

An IP address consists of four groups of numbers called **octets**, which are separated by periods. For example, 213 .0.0.1 is an IP address. An IP address consists of a **network portion** and a **host portion**. The network portion identifies the subnet that the computer belongs to. The host portion identifies the particular computer or node on that network.

IP addresses can either be dynamic (temporary) or static (permanent or fixed). A dynamic IP address is a temporary IP address that is assigned to you by a server (usually a DHCP server) when the computer is powered on. A static IP address is a permanent IP address that is set up on each individual computer. When your RouteFinder dials-up your ISP, your ISP can give it a fixed or dynamic IP address. Likewise when you power on your computer, the RF802EW can give your computer a dynamic or fixed IP address.

## ISDN TA

(Integrated Services Digital Network Terminal Adapter) ISDN is a high speed digital telephone connection involving the digitization of the telephone network using existing wiring. An ISDN Terminal Adapter can be thought of as an ISDN Modem.

## ISP (Internet Service Provider)

An organization that provides Internet services. An ISP is the company that provides the connection from your computer to the Internet. An ISP can offer a range of services, such as dial-up accounts, e-mail, web hosting or News.

## L

### LAN (Local Area Network)

A data network intended to serve an area of only a few square kilometers or less. This often means a small private network in companies.

## M

### ML-PPP (Also called MP or MPPP)

Stands for Multilink Point to Point Protocol and is an advancement of the PPP protocol that allows for the bridging or bundling of two ISDN or analog channels for faster connections.

### MAC address

The hardware address of a Device connected to a shared media. To find out the MAC address of your computer please see **Troubleshooting**.

## N

### NAT Technology

NAT is short for Network Address Translation. NAT is an Internet standard that enables a local-area network to use one set of IP addresses for internal traffic and a second set of IP addresses for external traffic. The RF802EW provides the necessary IP address translations. NAT is sometimes referred to as "IP Address Masquerading". This technology provides a type of firewall by hiding the internal IP addresses.

How does it work?

Every IP address on the Internet is a Registered or legal IP address. Therefore, no two IP addresses on the Internet are the same. For you to use your network device to access the Internet you need a registered IP address from your ISP (Internet Service Provider). Using a registered IP address on your Intranet or LAN is not necessary. When clients on your network start surfing the Internet, your RouteFinder will receive all the requests for information. The RouteFinder will dial-up your ISP and your ISP will give your RouteFinder a registered legal IP address. Your RouteFinder uses this IP address to request information saying, "send all information back to me at this IP address". In essence it appears as though all your clients requests are coming from that one IP address (hence the name IP masquerading). When all the information comes back through the RouteFinder, it sorts the data using an Address Translation Table and returns the data to the computer on your network that requested it.

---

If someone on the Internet tries to access your network, the firewall function of the RouteFinder stops the request. The device will not reverse translate network addresses unless you have specifically allowed this feature using the Virtual Server function (IP Mapping).

**NetworkAddress**

The network portion of an IP address. For a class A network, the network address is the first byte of the IP address. For a class B network, the network address is the first two bytes of the IP address. For a class C network, the network address is the first three bytes of the IP address. In each case, the remainder is the host address. In the Internet, assigned network addresses are globally unique.

**P****Packet**

A packet is a piece of a message transmitted over a packet-switching network. A packet contains the destination address of the message as well as the data. In IP networks, packets are often called datagrams.

**Port Number**

The term *port* can mean the connector on your computer or it can be thought of as a server number. Every service that travels over phone lines and modems has a standard port number. For example, the World Wide Web service uses the standard port number, **80** and the standard telnet port is **23**.

Port numbers are controlled and assigned by the IANA (Internet Assigned Numbers Authority). Most computers have a table in their systems containing a list of ports that have been assigned to specific services. You can also find lists of standard port numbers on the World Wide Web.

**Protocol**

A formal description of message formats and the rules two computers must follow to exchange those messages. You can think of protocols like languages. If two computers or devices aren't speaking the same language to each other, they won't be able to communicate.

**PPP (Point -to- Point Protocol)**

PPP enables dial-up connections to the Internet and is the method that your network device connects to the Internet. PPP is more stable than the older SLIP protocol and provides error checking features.

**R****Router**

A device which forwards traffic between networks. If you request information from a location on your network or the Internet, the router will route the request to the appropriate destination. The router's job is to listen for requests for IP addresses that are not part of your LAN and then route them to the appropriate network which may either be the Internet or another sub-network on your LAN.

**S****Server**

A provider of resources (e.g., file servers and name servers). For example your RouteFinder provides Internet Access and can be thought of as an Internet Access Server.

**Subnet**

A portion of a network that shares a common address component. On TCP/IP networks, subnets are defined as all devices whose IP Addresses have the same prefix. For example, all devices with IP addresses that start with 213 .0 .0 . would be part of the same subnet.

**SubnetMask /IPAddressMask**

Subnet mask is what is used to determine what subnet an IP address belongs to. Subnetting enables the network administrator to further divide the host part of the address into two or more subnets.

**T****TCP/IP (Transmission Control Protocol/Internet Protocol)**

A suite of communication protocols used to connect hosts on the Internet. Every computer that wants to communicate with another computer on the Internet must use the TCP/IP protocol to transmit and route data packets. The format of an IP address is a 32-bit numeric address written as four octets separated by periods. Each number can be zero to 255. Within an isolated network, you can assign IP addresses at random as long as each one is unique. However, connecting a private network to the Internet requires using registered IP addresses to avoid duplication.

The four groups of numbers (octets) are used to identify a particular network and host on that network. The InterNIC assigns Internet addresses as Class A, Class B, or Class C. Class A supports 16 million hosts on each of 127 networks. Class B supports 65,000 hosts on each of 16,000 networks. Class C supports 254 hosts on each of 2 million networks. Due to the large increase in access to the Internet, new classless schemes are gradually replacing the system based on classes.

**U****UDP (User Datagram Protocol)**

An Internet Standard transport layer protocol. It is a connectionless protocol that adds a level of reliability and multiplexing to IP.

# Index

## A

|                         |         |
|-------------------------|---------|
| Adding TCP/IP .....     | 97, 112 |
| Async Port .....        | 62      |
| Available Devices ..... | 55      |

## B

|                  |    |
|------------------|----|
| Back Panel ..... | 7  |
| Baudrate .....   | 69 |

## C

|                         |    |
|-------------------------|----|
| Cabling .....           | 12 |
| Callback Settings ..... | 63 |
| Callback Type .....     | 64 |
| Configuration .....     | 14 |
| Connection .....        | 9  |

## D

|                         |     |
|-------------------------|-----|
| Device IP Address ..... | 16  |
| DHCP .....              | 8   |
| Dial-up Retry .....     | 73  |
| Dimensions .....        | 9   |
| DNS .....               | 136 |

## E

|                         |     |
|-------------------------|-----|
| Enable IP Mapping ..... | 67  |
| Ethernet .....          | 136 |
| Event Messages .....    | 88  |

## F

|                              |        |
|------------------------------|--------|
| File and Print Sharing ..... | 98     |
| file sharing .....           | 117    |
| Filter Settings .....        | 78     |
| fixed-cost ADSL .....        | 17, 18 |
| Front Panel .....            | 7      |
| FTP .....                    | 68     |

## G

|                          |    |
|--------------------------|----|
| Gateway .....            | 76 |
| General Diagnostic ..... | 59 |
| General Settings .....   | 60 |

## H

|                             |    |
|-----------------------------|----|
| Hardware .....              | 9  |
| Hardware Installation ..... | 11 |

## I

|                        |          |
|------------------------|----------|
| Interface: .....       | 76       |
| Internet Browser ..... | 25       |
| IP .....               | 76       |
| IP Address/Name .....  | 88       |
| IP Routing .....       | 62       |
| IPCONFIG .....         | 132      |
| IPX/SPX .....          | 104, 108 |

## L

|                            |     |
|----------------------------|-----|
| LAN -to- LAN .....         | 117 |
| LAN DHCP Server .....      | 74  |
| LAN Ethernet Segment ..... | 61  |
| LMHosts .....              | 118 |
| Load Settings .....        | 57  |
| Local Client List .....    | 64  |
| Local Setting .....        | 64  |
| Login Script .....         | 70  |

## M

|                          |    |
|--------------------------|----|
| MAC Access Control ..... | 83 |
| Memory .....             | 9  |
| Modem String .....       | 72 |

## N

|                            |     |
|----------------------------|-----|
| NAT .....                  | 8   |
| NAT Disabled .....         | 117 |
| Netmask .....              | 76  |
| NT Server Connection ..... | 95  |

## P

|                             |         |
|-----------------------------|---------|
| Password .....              | 56      |
| PING .....                  | 132     |
| POP3 .....                  | 68      |
| Port Settings .....         | 69      |
| Power 5VDC .....            | 7       |
| Power Output .....          | 9       |
| PPP Settings .....          | 62      |
| Primary Network Logon ..... | 98, 109 |
| Privilege Level .....       | 79      |

## R

|                                |            |
|--------------------------------|------------|
| Radius .....                   | 65         |
| Refresh Device List .....      | 55, 82, 85 |
| Registering your product ..... | 128        |
| Regulatory Compliance .....    | 131        |
| Remote Access .....            | 66         |
| Reset .....                    | 7          |
| RouteFinder Manager .....      | 55         |
| routing .....                  | 117        |
| Routing Settings .....         | 76         |
| Routing Table .....            | 77         |
| Rx .....                       | 92         |

**S**

|                                       |     |
|---------------------------------------|-----|
| Safety .....                          | 11  |
| Save Settings to File .....           | 85  |
| Save to File .....                    | 87  |
| SMTP .....                            | 68  |
| Software Installation .....           | 14  |
| Software User License Agreement ..... | 126 |
| Statistics Tab .....                  | 92  |
| Status Tab .....                      | 91  |

**T**

|                            |     |
|----------------------------|-----|
| TCP/IP .....               | 107 |
| TCP/IP Tab .....           | 89  |
| Technical support .....    | 128 |
| Terminate Connection ..... | 86  |
| Test Connection .....      | 86  |
| Time Tab .....             | 90  |
| TRACERT .....              | 133 |
| Troubleshooting .....      | 120 |
| Tx .....                   | 92  |

**U**

|                                        |    |
|----------------------------------------|----|
| Unpacking .....                        | 11 |
| Upgrade Firmware .....                 | 58 |
| Using a Web browser to configure ..... | 25 |

**V**

|                      |    |
|----------------------|----|
| Virtual Server ..... | 67 |
|----------------------|----|

**W**

|                                                |     |
|------------------------------------------------|-----|
| WAN Ethernet Segment .....                     | 61  |
| WAN Speed .....                                | 9   |
| Warranty .....                                 | 9   |
| Web browser management and configuration ..... | 25  |
| Weight .....                                   | 9   |
| WINIPCFG .....                                 | 132 |
| Wireless Settings - RouteFinder Manager .....  | 82  |
| Wireless Settings - Telnet .....               | 52  |
| Wireless Settings - Web interface .....        | 31  |
| WWW .....                                      | 68  |